

COATS®

1175 Wheel Balancer



See
★ **Balancing Your
First Tire**
on page 1.

Installation Instructions Operating Instructions Safety Instructions Maintenance Instructions

READ these instructions before placing unit in service KEEP these and other materials delivered with the unit in a binder near the machine for ease of reference by supervisors and operators.

HENNESSY INDUSTRIES, INC.

1601 J. P. Hennessy Drive, LaVergne, TN USA 37086-3565 615/641-7533 800/688-6359 www.ammcoats.com
HENNESSY INDUSTRIES INC. Manufacturer of AMMCO®, COATS® and BADA® Automotive Service Equipment and Tools.

Manual Part No.: 85008884 02
Revision: 04/10

Table of Contents

Important Safety Instructions	iv - vi
Owner's Responsibility	v
Operator Protective Equipment	v
Definitions of Hazard Levels	v
Safety Notices and Decals	vi
Standard Safety Devices	vi
*Balancing Your First Tire	1
Principle Operating Parts	2
Know Your Unit	2
Power Switch	2
Operating the Balancer	3 - 7
Wheel Mounting	3
Standard Back Cone Mounting	3
Standard Front Cone Mounting	3
Control Panel And Display	4
Operation Functions Menu	5
Entering Wheel Dimensions	6
Automatic Dimension Presetting	6
Exact Positioning of the Adhesive Weight by Means of the Gauge with Clips	7
Result of Measurement	7
Recalculation Of The Unbalance	7
Behind Spoke (Hidden Weight)	8
Match Mount	9
Correction Modes	10
Manual Dimension Presetting (Use only in particular cases or for test)	11 - 12
Self-Calibration	13
Display Saver	13
Maintenance Instructions	14
Diagnostic Procedures	14
After Balance Vibration Problems	14
Installation Instructions	15 - 16
Receiving	15
Standard Accessories	15
Features	15
Specifications	15
Electrical Requirements	15
Floor and Space Requirements	16
Unpacking the Unit	16
Remove Balancer from Pallet	16
Connect to Power	16
Initial Testing	16
Hood Installation	17

IMPORTANT SAFETY INSTRUCTIONS

READ ALL INSTRUCTIONS

1. Eye and face protection recommendations:
“Protective eye and face equipment is required to be used where there is a reasonable probability of injury that can be prevented by the use of such equipment.” O.S.H.A. 1910.133(a) Protective goggles, safety glasses, or a face shield must be provided by the owner and worn by the operator of the equipment. Care should be taken to see that all eye and face safety precautions are followed by the operator. ALWAYS WEAR SAFETY GLASSES. Everyday glasses only have impact resistant lenses, they are not safety glasses.
2. Be sure that wheels are mounted properly, the hub nut engages the arbor for not less than four (4) turns, and the hub nut is firmly tightened before spinning the wheel.
3. Read and understand this manual before operating. Abuse and misuse will shorten the functional life.
4. Be sure the balancer is properly connected to the power supply and electrically grounded.
5. Do not operate equipment with a damaged cord or if the equipment has been dropped or damaged – until it has been examined and repaired by a qualified serviceman.
6. Do not let cord hang over edge of table, bench, or counter or come in contact with hot manifolds or moving fan blades.
7. If an extension cord is necessary, a cord with a current rating equal to or more than that of the equipment should be used. Cords rated for less current than the equipment may overheat. Care should be taken to arrange the cord so that it will not be tripped over or pulled.
8. Keep guards and safety features in place and in working order.
9. Wear proper clothing. Safety toe, non-slip footwear and protective hair covering to contain hair is recommended. Do not wear jewelry, loose clothing, neckties, or gloves when operating the balancer.
10. Keep work area clean and well lighted. Cluttered and/or dark areas invite accidents.
11. Avoid dangerous environments. Do not use power tools or electrical equipment in damp or wet locations, or expose them to rain.
12. Avoid unintentional starting. Be sure the balancer is turned off and power disconnected before servicing.
13. Disconnect the balancer before servicing.
14. Use only manufacturer’s recommended accessories. Improper accessories may result in personal injury or property damage.
15. Repair or replace any part that is damaged or worn and that may cause unsafe balancer operation. Do not operate damaged equipment until it has been examined by a qualified service technician.
16. Never overload or stand on the weight tray or any part of the balancer.
17. Do not allow untrained persons to operate machinery.
18. To reduce the risk of fire, do not operate equipment in the vicinity of open containers or flammable liquids (gasoline).
19. Adequate ventilation should be provided when working on or operating internal combustion engines.
20. Keep hair, loose clothing, fingers, and all parts of body away from moving parts.
21. Use equipment only as described in this manual.
22. Use only manufacturer’s recommended attachments and accessories.

SAVE THESE INSTRUCTIONS

Owner's Responsibility

To maintain machine and user safety, the responsibility of the owner is to read and follow these instructions:

- Follow all installation instructions.
- Make sure installation conforms to all applicable Local, State, and Federal Codes, Rules, and Regulations; such as State and Federal OSHA Regulations and Electrical Codes.
- Carefully check the unit for correct initial function.
- Read and follow the safety instructions. Keep them readily available for machine operators.
- Make certain all operators are properly trained, know how to safely and correctly operate the unit, and are properly supervised.
- Allow unit operation only with all parts in place and operating safely.
- Carefully inspect the unit on a regular basis and perform all maintenance as required.
- Service and maintain the unit only with authorized or approved replacement parts.
- Keep all instructions permanently with the unit and all decals/labels/notices on the unit clean and visible.
- Do not override safety features.

Operator Protective Equipment

Personal protective equipment helps make tire servicing safer. However, equipment does not take the place of safe operating practices. Always wear durable work clothing during tire service activity. Loose fitting clothing should be avoided. Tight fitting leather gloves are recommended to protect operator's hands when handling worn tires and wheels. Sturdy leather work shoes with steel toes and oil resistant soles should be used by tire service personnel to help prevent injury in typical shop activities. Eye protection is essential during tire service activity. Safety glasses with side shields, goggles, or face shields are acceptable. Back belts provide support during lifting activities and are also helpful in providing operator protection. Consideration should also be given to the use of hearing protection if tire service activity is performed in an enclosed area, or if noise levels are high.

Definitions of Hazard Levels

Identify the hazard levels used in this manual with the following definitions and signal words:

DANGER

Watch for this symbol:



It Means: Immediate hazards, which will result in severe personal injury or death.

WARNING

Watch for this symbol:



It Means: Hazards or unsafe practices, which could result in severe personal injury or death.

CAUTION

Watch for this symbol:



It Means: Hazards or unsafe practices, which may result in minor personal injury or product or property damage.



Watch for this symbol! It means BE ALERT! Your safety, or the safety of others, is involved!

Safety Notices and Decals

WARNING

Failure to follow danger, warning, and caution instructions may lead to serious personal injury or death to operator or bystander or damage to property. Do not operate this machine until you read and understand all the dangers, warnings and cautions in this manual. For additional copies of either, or further information, contact:

Hennessy Industries, Inc.
1601 J.P. Hennessy Drive
LaVergne, TN 37086-3565
(615) 641-7533 or (800) 688-6359
www.ammcoats.com

WARNING

Maximum Size of Wheel Rating	Weight	Diameter	Width
	150 lbs.	40 in.	18.6 in.

8111883 01

Standard Safety Devices

- Stop push button for stopping the wheel under emergency conditions.
- A hood guard of high impact plastic that is designed to prevent the counterweights from flying out in any direction except towards the floor.

WARNING

RISK OF EXPLOSION
This equipment has internal arcing or sparking parts which should not be exposed to flammable vapors. Do not locate in a recessed area or below floor level.

THIS EQUIPMENT MUST BE EARTH-GROUNDED
The earth-ground connector built into the power cord provides protection to reduce the risk of electrical shock.



CAUTION

Do not use below garage floor or grade level.
Disconnect power before servicing this equipment.
To prevent electrical shock, do not remove cover. No user servicable parts inside. Refer servicing to qualified service personnel.

May Be Protected by one or more of the following patents:
USA - 4,423,632 - 4,499,768 - 4,939,941 - 5,311,777 - 5,337,256
AUSTRALIA - 564038

8113547 01

NOTICE



Read entire manual before assembling, installing, operating, or servicing this equipment.

★ **Balancing Your First Tire**

1. Turn the machine OFF then ON (resets machine).

Note: The machine wakes up using standard clip-on wheel weight locations (c1 & c2) and wheel dimensions.

2. Mount a tire/wheel on the balancer that will use standard clip-on wheel weights.

Use the most appropriate mounting method.

3. Always remove any weights already attached to the wheel.

4. Enter A & D wheel dimensions using offset arm.

Automatic Measurement — pull offset arm out to the wheel, hold it still at clip-on weight position against wheel flange. Return arm to home position.



Offset Arm At Clip-On Weight Location

5. Enter Width wheel dimension.

Use plastic calipers to measure wheel width. Use keypad to enter Width value.

6. Lower the hood, press Start; wheel spins and unbalances are measured and displayed.

The corrective weight amount appears in the digital readout windows.

7. Raise hood after tire stops rotating.

Note: Wait for wheel to stop before raising the hood.

8. Rotate wheel to inboard (left plane) position of unbalance.

9. Attach inboard (left plane) corrective weight.

Attach specified weight amount at top-dead-center on inside flange of wheel.

10. Rotate wheel to outboard (right plane) position of unbalance.

11. Attach outboard (right plane) corrective weight.

Attach specified weight amount at top-dead-center on outside flange of wheel.

12. Lower the hood to respin the tire/wheel and check balance.

Your weight readings should now be 0.00.

Note: Throughout this manual tire dimensions are referred to as A, W, and D, see figure 2.

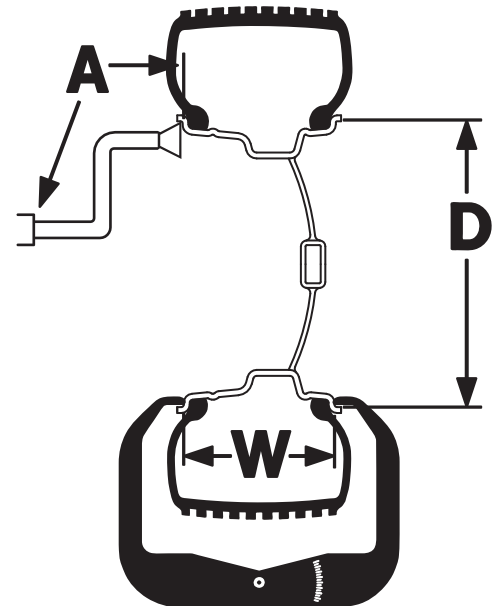

A, W, and D Tire Dimensions

Principle Operating Parts

Know Your Unit

Compare this illustration with the unit before placing it into service. Maximum performance and safety will be obtained only when all persons using the unit are fully trained in its parts and operation. Each user should learn the function and location, of all controls.

Prevent accidents and injuries by ensuring the unit is properly installed, operated and maintained.

- A Control Panel or Video Display Panel**
- B Plug (back of machine)**
- C ON/OFF**
- D Weight Tray with Pockets for Corrective Weights**
- E Offset Arm, Measures A & D of Tire/Wheel (shown in home position)**
- F 40mm Shaft**
- G Hood Guard**

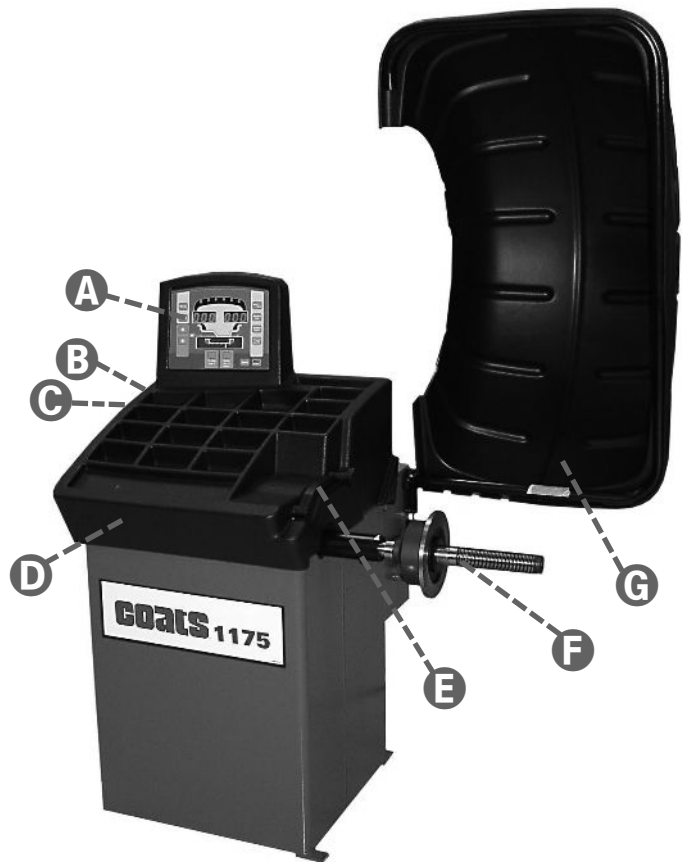

Note: Wheel weights are referred to as Clip-on or Tape-A-Weight™. Figure 3 shows an example of each weight.



Corrective Weight Examples: For Best Results, use BADA® Brand Wheel Weights.

Power Switch

The ON/OFF switch location is on the side of the balancer; below the weight tray.

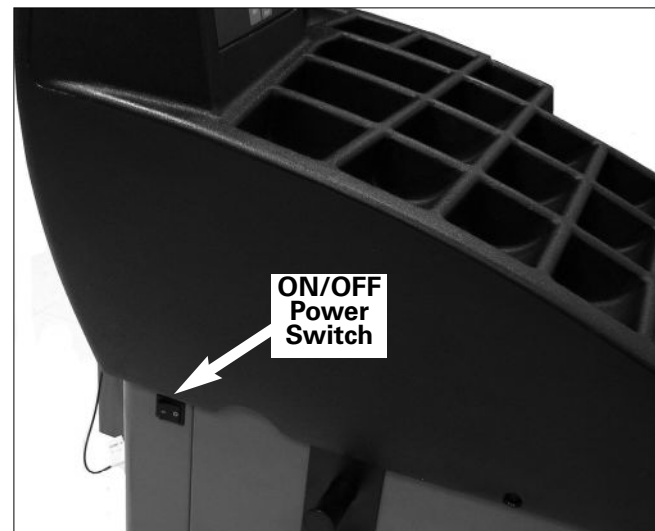

On/Off Switch

Operating the Balancer

Wheel Mounting

Select the most appropriate mounting method for the wheel you are balancing. Using the proper method ensures secure mounting and safe balancer operation, and prevents damage to the wheel.

On most wheels, the inner side of the wheel hub usually has the most uniform surface for wheel balancing. Always center the wheel by the most uniform shaped side of the hub to achieve the most accurate balance.

Regardless of mounting type, always make sure that the wheel is forced firmly against the shaft faceplate and that the hub nut engages the threaded shaft for at least four complete turns. To assist in centering the wheel properly, rotate the wheel and the shaft while tightening the hub nut.



Failure to tighten the hub nut properly may result in the wheel dismounting, causing personal injury and property damage.

Standard Back Cone Mounting

Most original equipment and steel wheels can be mounted properly using this method. The wheel is centered on a cone from the inner side of the hub.

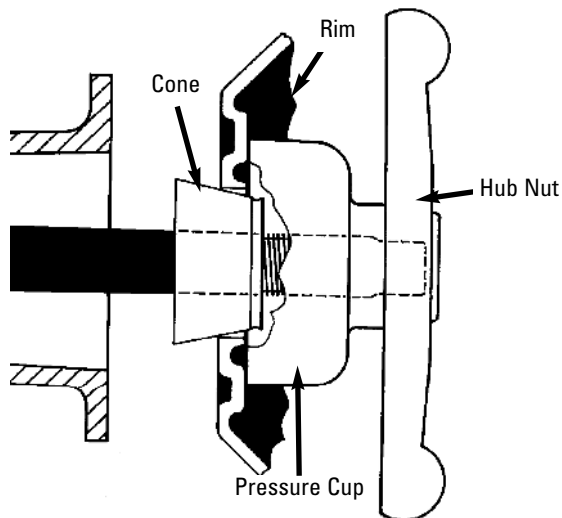

Back Cone Mounting

1. Select the cone that best fits the center hole in the wheel. Slide the cone onto the shaft with the large end towards the faceplate.
2. Lift wheel onto the shaft and center it on the cone.
3. Attach the pressure cup to the hub nut and install the assembly onto the shaft. Tighten securely.

Note: Use a nylon spacer (no mar ring) to protect custom wheel finishes.

4. Thread the hub nut onto the shaft, and tighten it against the wheel. The wheel must be forced firmly against the faceplate. The hub nut must engage the threads for at least three full turns.

Note: If the hub nut will not tighten completely, use the front cone mounting method.

Standard Front Cone Mounting

A wheel should be centered by the outer side of the hub only when the inner surface will not provide an accurate surface to center on.

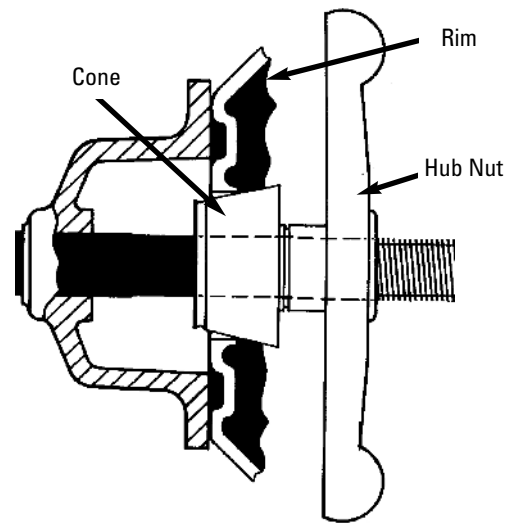

Front Cone Mounting

1. Select the cone that best fits the center hole in the wheel.
2. Lift the wheel onto the shaft and slide it back against the shaft faceplate.
3. Slide the cone onto the shaft and into the center of the wheel. You will need to lift the tire to seat the cone in the center hole.
4. Install the hub nut (without pressure cup) onto the shaft. Tighten it securely against the cone. The hub nut must engage the threads for at least three full turns.

Note: If the hub nut will not tighten completely because of a lack of threads, use an additional cone as a spacer between the mounting cone and the hub nut. The wheel must be forced firmly against the faceplate.

Control Panel And Display

1175 Control Panel

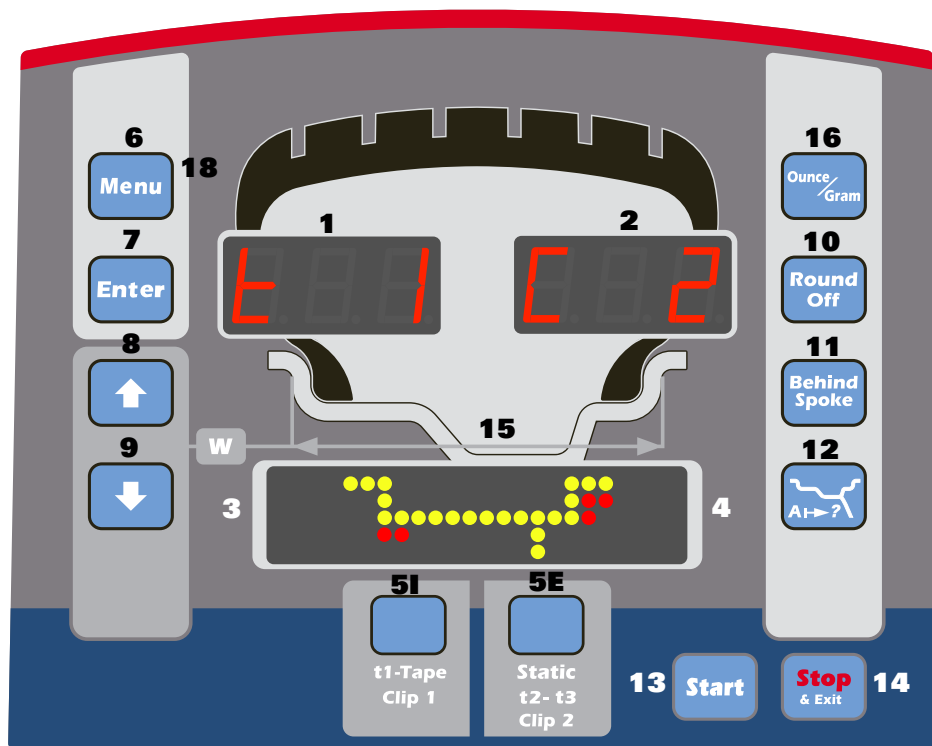

- | | | | |
|-----|---|----|-------------------------------|
| 1-2 | Digital readouts, AMOUNT OF UNBALANCE, inside/outside | 11 | Push button, SPLIT |
| 3-4 | Digital readouts, POSITION OF UNBALANCE, inside/outside | 12 | Position repeater push button |
| 5I | INSIDE correction position selection button | 13 | Push button, cycle start |
| 5E | EXTERNAL SIDE and STATIC correction | 14 | Push button, emergency/EXIT |
| 6 | Push button, FUNCTIONS MENU | 15 | Dot matrix function display |
| 7 | Push button, MENU selection confirmation | 16 | oz/gr selection push button |
| 8 | Maximize/MENU button | | |
| 9 | Minimize/MENU button | | |
| 10 | Push button, unbalance reading < 0.25 oz (5 g) | | |

Note: Only press buttons with your fingers. Never use the weight hammer or other pointed objects to press buttons.

Operation Functions Menu

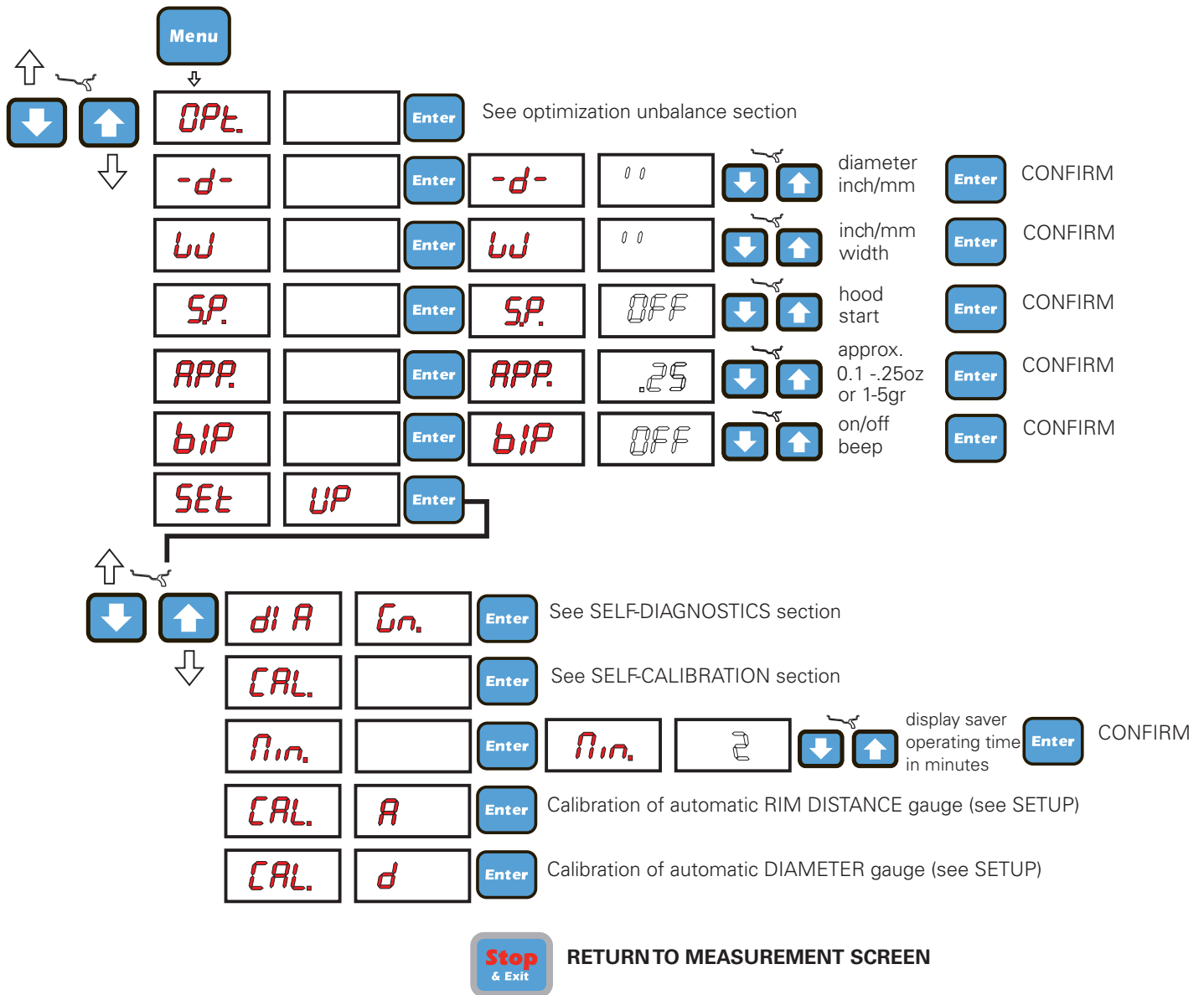

Entering Wheel Dimensions

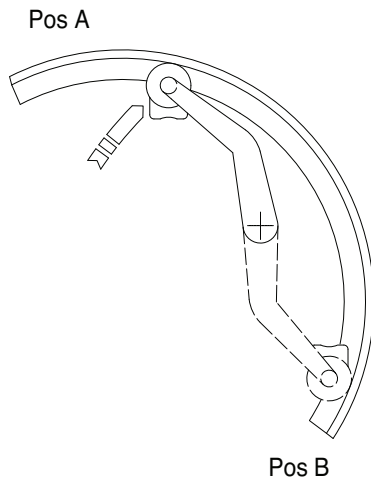

For clip-on weights, use gauge in the top position A.

For adhesive weights, use the gauge as preferred in top position A or bottom position B.

Note: Always use the round part of the striker plate resting on the rim.



Indication of gauge in movement

Automatic Dimension Presetting

The machine automatically detects the correct balancing program for steel and aluminum rims.

The counterweight position proposed may be changed using the 5I and 5E buttons.

Counterweights c1-c2/STATIC/t1-t3/c1-t3

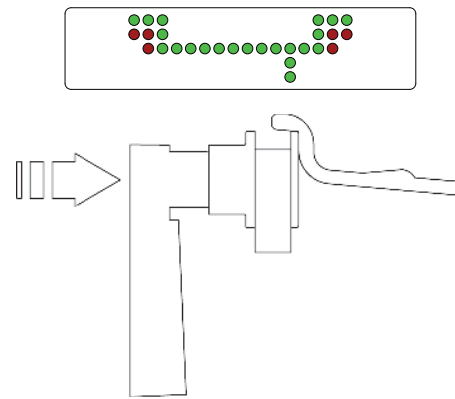

Pull out the gauge as far as the inner edge of the rim. Hold it in this position until a "beep" is heard.

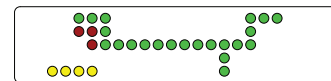
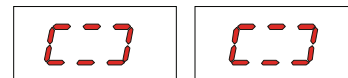

Indication of dimensions acquired

Return the gauge to rest position. The machine has automatically detected DISTANCE + DIAMETER and goes to MANUAL WIDTH SETTING.

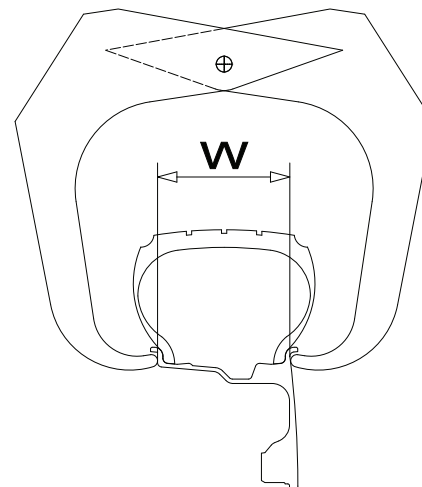

The nominal width is normally stamped on the rim; if not, proceed to measure dimension "W" with the caliber gauge (supplied as standard).

Note: Once the dimensions have been set, you can in any case change the correction method by pressing the 5I and 5E buttons (see CORRECTION MODE).

Exact Positioning of the Adhesive Weight by Means of the Gauge with Clips

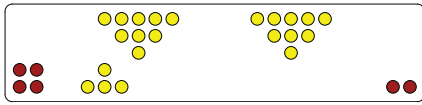
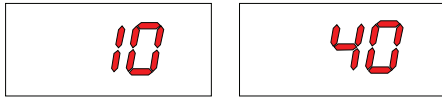
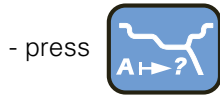

- Fit the correction weight in the specific gauge seat with the adhesive part facing upwards.

- bring the wheel into correct angular position for the plane to be corrected

- withdraw the gauge until the correction plane indication arrows turn green



INSIDE CORRECTION POSITION

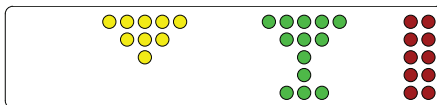

OUTSIDE CORRECTION POSITION

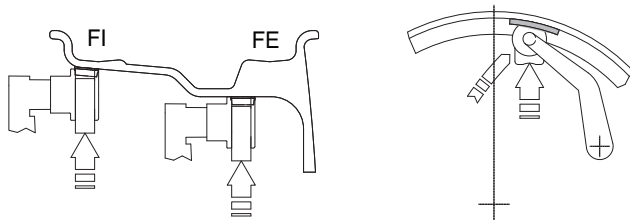

- Rotate the gauge until the correction weight adheres to the rim

- the fact that the weight application position is no longer vertical is automatically compensated

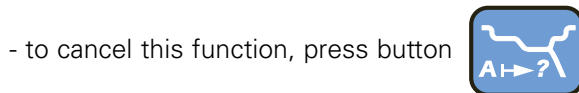

again

Result of Measurement

After performing a balancing spin, the amounts of unbalance are shown on the digital readouts.

The illuminated LEDs 3 and 4 indicate the correct angular position of the wheel to mount the counterweights (12 o'clock).

Correction of inner side

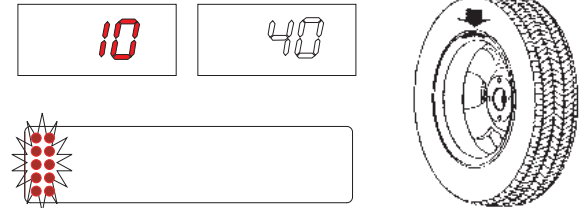

Correction of outer side

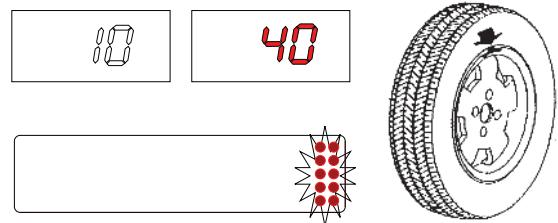

If the unbalance is less than the threshold value selected,  is displayed instead of the unbalance

value, with  the values below the threshold can be read.

Recalculation Of The Unbalance

Automatic on pressing the  button.

Behind Spoke (Hidden Weight)

The SPLIT function is used to position the adhesive weights behind the wheel spokes so that they are not visible. This function should be used only in the case of static unbalance or where the hidden adhesive weight is to be applied on the outside. Input the wheel dimensions and do a spin.

Start the SPLIT function as follows:

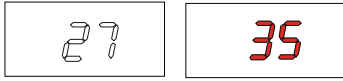

- Place the wheel in the outside unbalance correction position.

- Set one of the top spokes (preferably the one to the left of the unbalance) to 12 o'clock.

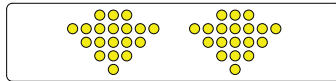

Indication of first positioning detected

- Follow the UP/DOWN indication of the arrows and set the second top spoke to 12 o'clock.

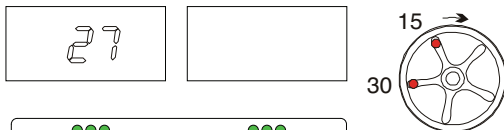

- Place the first Split unbalance in correction position 1

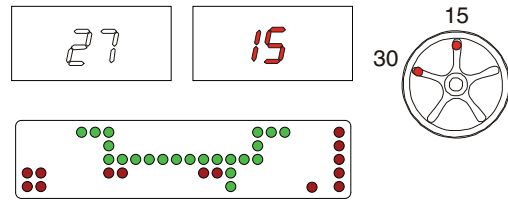

- Correction position 1 (indicator 1)

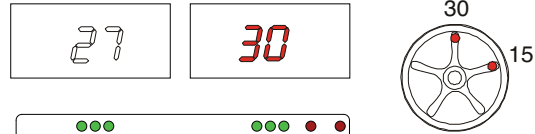

- Correction position 2 (indicator 2)

To return to normal unbalance display, press any button.

To carry out a new spin, press the  button.

Match Mount

- This function serves to reduce the amount of weight to be added in order to balance the wheel
- It is suitable for static unbalance exceeding 1.5oz (30g).

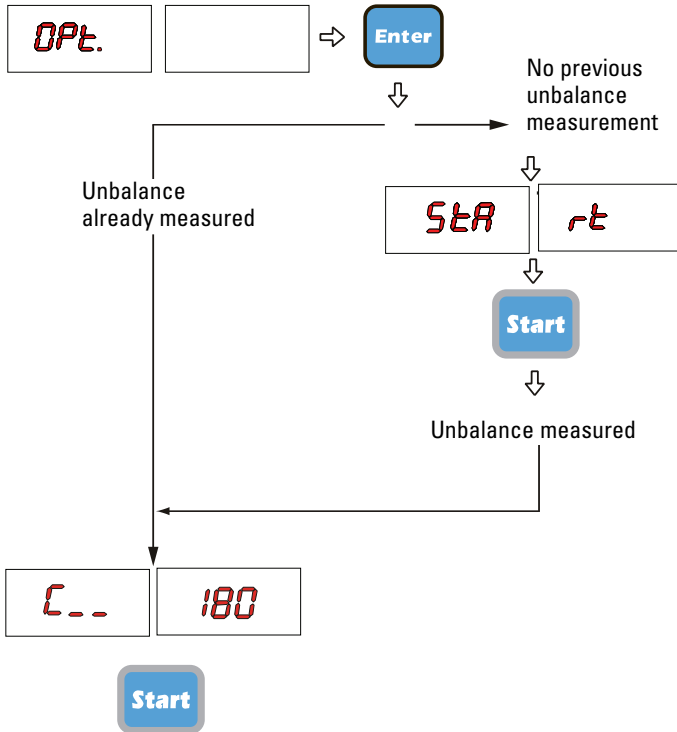

- It improves the residual eccentricity of the tire.
- With a piece of chalk make a reference mark on the flange and the rim.
- With the aid of a tire remover, turn the tire on the rim by 180°.
- Refit the wheel in such a way that the reference marks on the rim and the flange coincide.



- RH display: percentage reduction valve.
- LH display: actual static unbalance valve which can be reduced by rotation.

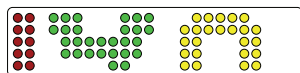

RIM IN POSITION INDICATION

- Mark the tire (12 o'clock position).

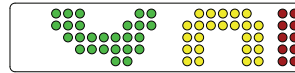

TIRE IN POSITION INDICATION

- Mark the rim (12 o'clock position).

Turn the tire on the rim until the marks correspond to obtain the optimization shown on the display.



CANCEL OPTIMIZATION IN ANY PHASE.

Correction Modes

From the measurement screen, press **Static** or

Tape Weight Choice

button to select the type required. If a

spin has already been performed, the processor automatically recalculates, for each change of mode, the amounts of unbalance according to the new calculation.

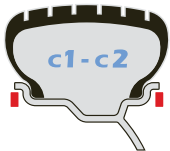

Balancing of steel or light alloy rims with application of clip-on weights on the rim edges.



The static mode is necessary for motorcycle wheels or when it is not possible to place the counterweights on both sides of the rim.

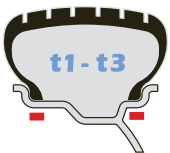

Balancing of light alloy rims with application of adhesive weights on the rim shoulders.

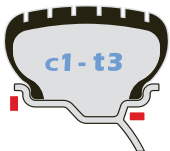

Combined application: adhesive weight outside and clip-on weight inside.

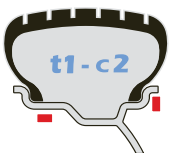

Combined balancing: adhesive weight on the inside and clip-on weight on the outside.



Balancing of light alloy rims with hidden application of the outer adhesive weights. The dimensions can be set. (see MANUAL SETTING t1-t2)

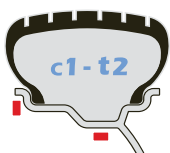

Combined application: clip-on weight inside and hidden adhesive weight on outside (Mercedes). The dimensions can be set. (see MANUAL SETTING c1-t2)

To check the type of correction selected, hold the button **Display Balance Mode**, while on the matrix display the rim

symbol appears with the correction weights flashing in the right application position.

This information remains displayed only as long as the button is held down. To cancel any type of correction and return directly to dynamic unbalance, press

the button **Tape Weight off** will put you back to c1-c2.

Manual Dimension Presetting (Use only in particular cases or for test)

c1-c2/STATIC/t1-t3/c1-t3 Wheel Rims (use for setting dimensions in AUTO CALIBRATION)

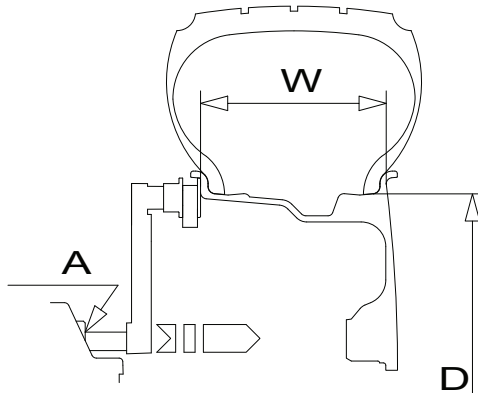
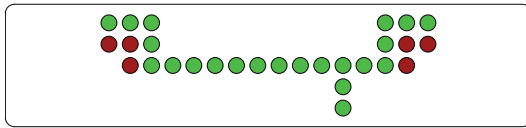

- Setting:



Set with the rated width that, in general, is shown on the rim, or measure width "W" with the caliper gauge supplied.



- Press the button for more than 2 seconds



- Preset using the nominal diameter "D" indicated on the tire



- Press the button for more than 2 seconds

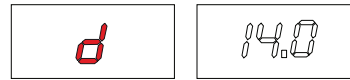

- Preset using distance "A" for the inside of the wheel from the machine.

Note: This setting is also valid for the correction modes STATIC/t1-t3/c1-t3.

t1-t2 Rims

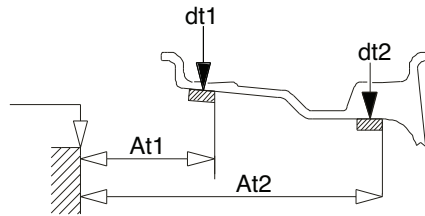
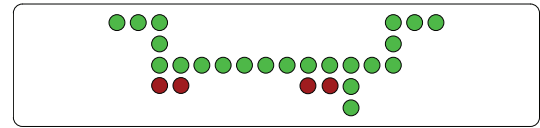

- Setting:

To go to these functions:



- press one of the two buttons for more than 2 seconds.



- to change press one of two buttons.



- to change press one of two buttons.



- to change press one of two buttons.

Note: when dt2 is not set, dt2 = dt1 - 1" is automatic.

c1-t2 Rims

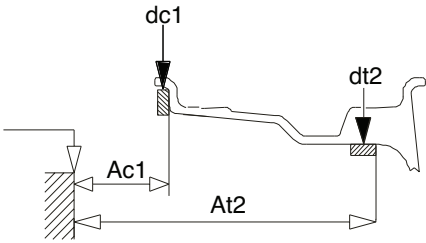
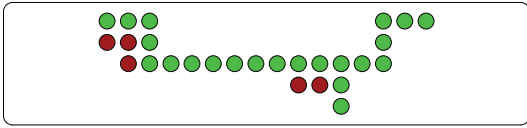

- Setting:

To go to these functions:



- press one of the two buttons for more than 2 seconds.



- to change press one of two buttons.



- to change press one of two buttons.



- to change press one of two buttons.

Note: when dt2 is not set, $dt2 = dc1 - 2''$ is automatic.

Self-Calibration

For machine self-calibration proceed as follows:

- Fit a wheel with steel rim of average dimensions on the shaft. Example 6" x 14" (± 1 ")
- Preset the exact dimensions of the wheel mounted.

IMPORTANT !! Presetting of incorrect dimensions would mean that the machine is not correctly calibrated, therefore all subsequent measurements will be incorrect until a new self-calibration is performed with the correct dimensions!!

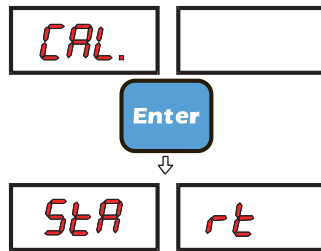

- Perform a spin under normal conditions.

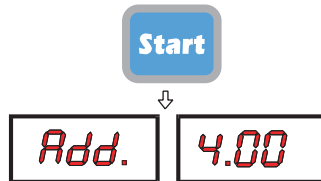

- Add a 4.00 oz (ounce mode) or 100 gr. (gram mode) calibration weight on outside in any angular position.

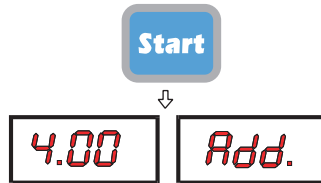

- Shift the calibration weight straight across to the inside; keeping the same angular position.

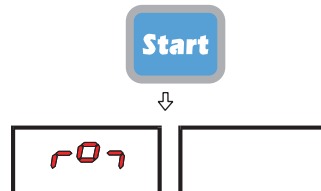

- Rotate the wheel so to have the calibration weight to the 12 o'clock position.

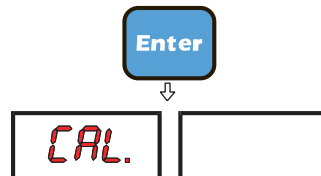

END OF SELF-CALIBRATION



CANCEL SELF-CALIBRATION IN ANY PHASE.

Display Saver

A display saver function can be enabled which allows temporarily replacing the information on the display with moving symbols. This function is activated when the balancing machine is not used for longer than the time set in the relevant setup:

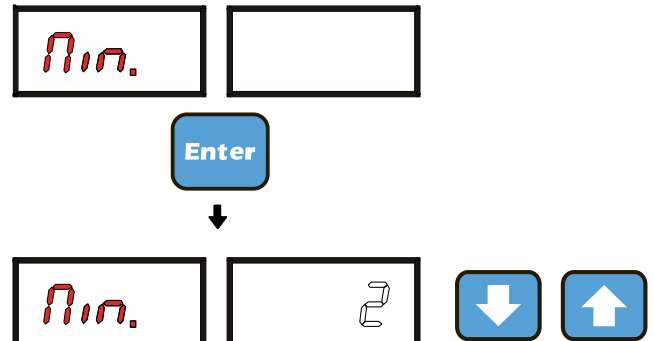

Modifies the time expressed in minutes.



CONFIRM

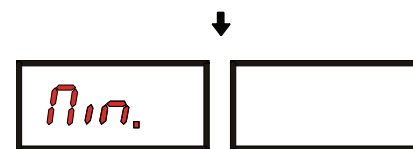

Setting 0, the display saver is automatically disabled.

The display saver is not active in the setup menu of the balancing machine.

To return to normal functioning of the balancing machine, press any button or move the wheel.

Maintenance Instructions

The balancer requires only minor maintenance to keep the unit operating properly.

1. Keep the display clean and clear. Use a damp cloth. Do not use cleaners or solvents which leave oily or filmy residues behind.

2. Keep the adapters, cones, faceplate, threaded shaft, pressure cup, and hub nut clean. Grease and dirt buildup will cause inaccurate balancing and premature wear. Clean these items at least once a day with a vaporizing solvent.

3. Clean weight tray and any accessory posts, pegs, or storage shelves with a vaporizing solvent. Weights stored in a dirty tray may pick up grease and dirt which may keep them from securely attaching to the wheel.



Use common sense, this is an electrical device. Exposing the balancer to water, either by hose or bucket, or by exposure to rain or snow, may cause risk of shock or electrocution to operator or bystanders. Place, store, and operate the balancer only in a dry, sheltered location.



Do not hose down with water or bucket wash the balancer. Extensive damage to the balancer will result. Sensitive electronic components, wiring harnesses, and other devices housed in the balancer are not intended to be exposed to water.

4. Keep the area around the balancer clear. Remove any tools or other items that are leaning against the balancer. Keep the area under the balancer clear. Remove any items that may cause the balancer to not sit level. Be particularly cautious of new or used wheel weights on the floor, as they may cause personal injury due to falls.

5. Use only COATS® accessories. Accessories from other manufacturers may not fit or function properly, and may damage the balancer.

Diagnostic Procedures

After Balance Vibration Problems

If vibration is still present after balancing the wheels and driving the vehicle on smooth pavement, remove the wheels and recheck the balance. If a wheel is out of balance the cause maybe:

- Wheel was not mounted/centered correctly on the balancer.
- A weight has come off the wheel (possibly the wrong clip style). Remove the other weights from the wheel and rebalance.
- Foreign material inside the tire. Remove the tire from the wheel, remove the foreign material, and remount. Remove wheel weights and rebalance the wheel.
- Stones or other foreign objects caught in the tire tread or rim. Remove the objects. Check and rebalance if needed.

If the balancer still indicates the wheels are balanced to within 0.10 ounces on both inner and outer displays, the problem is not in the balance of the wheels. Check the following possible sources of vibration:

- Tire pressure. Bring all tires up to the recommended PSI.
- Radial or lateral runout in the tire or wheel. Replace the damaged part.
- Unbalance in wheel covers or trim rings. Remove the wheel covers or trim rings and test drive. If the vibration is gone, remove the shaft and use an appropriate adapter to mount the wheel to the balancer. Balance the wheel with the wheel cover or trim ring attached to the wheel.
- Incorrectly mounted wheel. Remount correctly.
- Damaged wheel bolt holes. Replace wheel.
- Worn universal joints. Replace as required.
- Drive shaft unbalance or damaged. Balance, repair, or replace.
- Unbalance in brake rotor(s) or drum(s).
- Suspension out of alignment. Align the vehicle and replace any damaged or worn parts.

Installation Instructions

A factory trained COATS® Service Technician must perform the install, setup, and initial test procedures on your wheel balancer. Do not attempt to install and setup the unit yourself. Accurate and reliable operation of your unit depends on proper installation. Please contact COATS® directly at 1-800-688-9240 for the Certified Service Partner nearest you.

Receiving

The shipment should be thoroughly inspected as soon as it is received. The signed bill of lading is acknowledgement, for the carrier, of receipt in good condition of the shipment covered by our invoice.

If any of the goods called for on this bill of lading are shorted or damaged, do not accept them until the carrier makes a notation of the shorted or damaged goods on the freight bill. Do this for your own protection.

NOTIFY THE CARRIER AT ONCE if any hidden loss or damage is discovered after receipt and request him to make an inspection. If the carrier will not do so, prepare an affidavit to the effect that you have so notified the carrier (on a certain date) and that he has failed to comply with your request.

IT IS DIFFICULT TO COLLECT FOR LOSS OR DAMAGE AFTER YOU HAVE GIVEN THE CARRIER A CLEAR RECEIPT.

File your claim with the carrier promptly. Support your claim with copies of the bill of lading, freight bill, invoice, and photographs, if possible.

Although COATS responsibility ceases upon delivery of the shipment to the carrier, we will gladly assist in tracing lost shipments. Our willingness to assist in every possible manner does not make COATS responsible for collection of claims, or replacement of lost or damaged materials.

Standard Accessories

- Built-in Weight Tray
- 3 Back Cones
- Hub Nut
- Pressure Drum
- Rim Width Calipers

Features

- Balances Most Automotive Wheels
- Single-Spin Dynamic Two-Plane or Static Balancing
- Vertical Wheel Mounting
- Back Cone and Front Cone Mounting
- “No Bolt-Down” Installation
- Scratch Resistant Control Panel
- Easy-To-Read LEDs and Displays
- Automatic Calibration
- Removable Shaft Stud
- Automatic Rim Gauge Return
- Dynamic, Static, and Alloy Operating Modes

Specifications

- | | |
|--|--------------------|
| • Weight (excluding adapter) | 150 lbs. |
| • Single-phase power supply | 115 V |
| • Protection class | IP 54 |
| • Max power consumption | 0.8 Kw |
| • Balancing speed | < 100 rpm |
| • Cycle time for average wheel (14 kg) | 6-8 seconds |
| • Max.resolution of measurement | .1 oz |
| • Position resolution | ± 1.4 ° |
| • Average noise | < 70dB (A) |
| • Rim-machine distance | 0 - 252 mm |
| • Rim width setting range | 1.5 to 18.6 inches |
| • Diameter setting range | 10 to 40 inches |

Electrical Requirements

See serial tag for the appropriate power requirements of your machine.

Always have a qualified electrician install the proper receptacles in accordance with state and local codes.

Floor and Space Requirements

The balancer must be located on a flat floor of solid construction, preferably concrete. The balancer must sit solidly on its three feet. If the balancer is not level, does not sit solidly on its three feet, or is placed on an unstable floor, the balancer will not function properly and may produce inaccurate balance readings.

Do not operate the balancer while it is on the pallet.

Select a location for the balancer that provides a level, solid floor, and adequate clearance around and above the balancer. Make sure the location selected has enough room above and behind the unit so the hood can be raised completely. The location must also provide working room for mounting and removing wheels. Make sure the area has adequate lighting

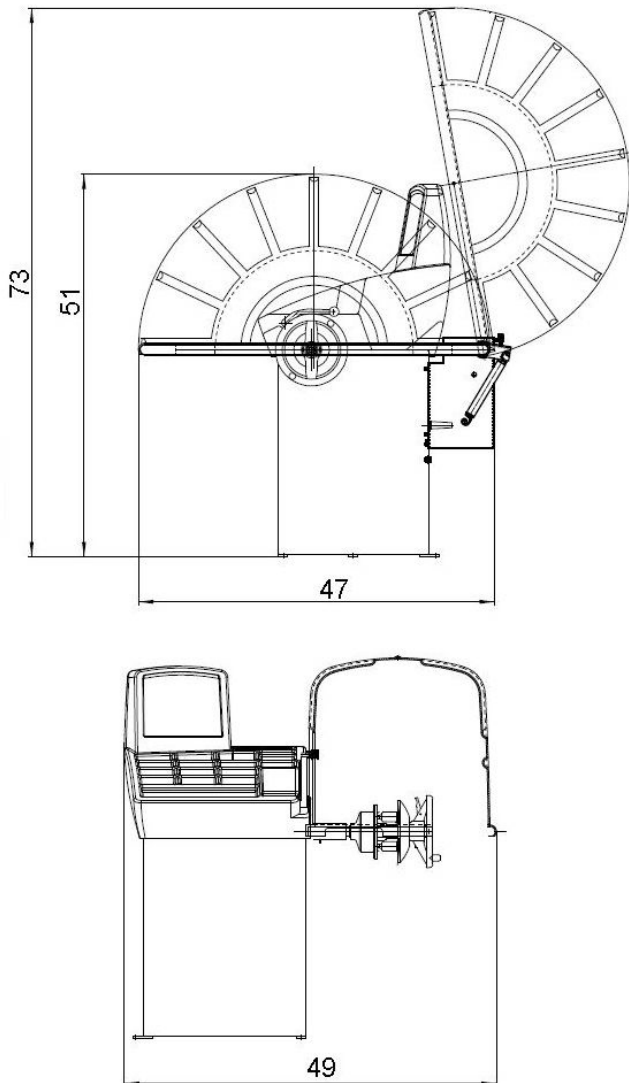

Space Requirements

Unpacking the Unit

1. Remove the shipping carton from the pallet.
2. Remove all loose parts and accessories packed around the unit.

Remove Balancer from Pallet

3. Remove the shipping bolts that hold the balancer to the pallet.



Do not use the control panel, control panel base, accessory storage, faceplate, hood or shaft to lift the balancer.



Use help to remove the balancer from the pallet. The unit is heavy and the weight is not evenly distributed. Dropping the unit may cause personal injury or equipment damage.

4. Lift the balancer off the pallet and place it in its operating location.
5. Install and tighten the threaded stud into the end of the motor shaft.

Connect to Power

Your factory trained COATS® Service Technician should do the final check to verify the power installation before connecting the balancer to a power supply. Failure due to improper power connection may void the warranty.

Initial Testing

1. Plug the unit into an appropriate power outlet. If the circuit breaker for the outlet is off, turn it on.
2. Turn the balancer on. The power switch is on the back of the unit.

Hood Installation

1. Install plastic bushing on end of hood tube.
2. Insert hood tube through hole and slide through hood mounting bracket. The bushing will only fit one way due to its molding.
3. Install second plastic bushing on the end of the hood tube protruding from the bracket.
4. Slide on the stop ring. The set screws may need to be loosened to install slide ring. Adjust the stop ring so the notch is parallel to the floor when the hood is in the down position.
5. Install the plug in the end of the hood tube.
6. Tighten the set screws to secure stop ring in place.
7. Raise the hood.
8. Install hood spring. This attaches to the cam studs on the hood bar and mounting bracket.
9. Lower the hood.
10. Screw on hood switch with two screws. The height of the switch will need to be adjusted to ensure the switch button is up when the hood is down. The switch button should fit neatly in the cutout of the stop ring.
11. Connect the switch wiring end to the three-prong connector on the back panel of the chassis.
12. Test the hood switch with the auto spin feature to ensure proper installation. If problems check the height of the hood switch button for proper operation.

