

# COATS®

## ProRide Diagnostic ProRide Diagnostic PL Wheel Balancer Models



See  
★ **Balancing Your  
First Tire**  
on page 5.

### **Safety Instructions Set-up Instructions Operation Instructions Maintenance Instructions**

READ these instructions before placing unit in service. KEEP these and other materials delivered with the unit in a binder near the machine for ease of reference by supervisors and operators.

**HENNESSY INDUSTRIES, INC.**

1601 J. P. Hennessy Drive, LaVergne, TN USA 37086-3565 615/641-7533 800/688/6359 www.ammcoats.com  
HENNESSY INDUSTRIES INC. Manufacturer of AMMCO®, COATS® and BADA® Automotive Service Equipment and Tools.

Manual Part No.: 85607587 00  
Revision: 07/11

## IMPORTANT SAFETY INSTRUCTIONS

### READ ALL INSTRUCTIONS

1. Eye and face protection recommendations:  
“Protective eye and face equipment is required to be used where there is a reasonable probability of injury that can be prevented by the use of such equipment.” O.S.H.A. 1910.133(a) Protective goggles, safety glasses, or a face shield must be provided by the owner and worn by the operator of the equipment. Care should be taken to see that all eye and face safety precautions are followed by the operator. ALWAYS WEAR SAFETY GLASSES. Everyday glasses only have impact resistant lenses, they are not safety glasses.
2. Do not disable hood safety interlock system, or in any way shortcut safety controls and operations.
3. Be sure that wheels are mounted properly, the hub nut engages the arbor for not less than four (4) turns, and the hub nut is firmly tightened before spinning the wheel.
4. Read and understand this manual before operating. Abuse and misuse will shorten the functional life.
5. Be sure the balancer is properly connected to the power supply and electrically grounded.
6. Do not operate equipment with a damaged cord or if the equipment has been dropped or damaged – until it has been examined and repaired by a qualified serviceman.
7. Do not let cord hang over edge of table, bench, or counter or come in contact with hot manifolds or moving fan blades.
8. If an extension cord is necessary, a cord with a current rating equal to or more than that of the equipment should be used. Cords rated for less current than the equipment may overheat. Care should be taken to arrange the cord so that it will not be tripped over or pulled.
9. Keep guards and safety features in place and in working order.
10. Wear proper clothing. Safety toe, non-slip footwear and protective hair covering to contain hair is recommended. Do not wear jewelry, loose clothing, neckties, or gloves when operating the balancer.
11. Keep work area clean and well lighted. Cluttered and/or dark areas invite accidents.
12. Avoid dangerous environments. Do not use power tools or electrical equipment in damp or wet locations, or expose them to rain.
13. Avoid unintentional starting. Be sure the balancer is turned off and power disconnected before servicing.
14. Disconnect the balancer before servicing.
15. Use only manufacturer’s recommended accessories. Improper accessories may result in personal injury or property damage.
16. Repair or replace any part that is damaged or worn and that may cause unsafe balancer operation. Do not operate damaged equipment until it has been examined by a qualified service technician.
17. Never overload or stand on the weight tray or any part of the balancer.
18. Do not allow untrained persons to operate machinery.
19. To reduce the risk of fire, do not operate equipment in the vicinity of open containers or flammable liquids (gasoline).
20. Adequate ventilation should be provided when working on or operating internal combustion engines.
21. Keep hair, loose clothing, fingers, and all parts of body away from moving parts.
22. Use equipment only as described in this manual.
23. Use only manufacturer’s recommended attachments and accessories.

### SAVE THESE INSTRUCTIONS

## Owner's Responsibility

To maintain machine and user safety, the responsibility of the owner is to read and follow these instructions:

- Follow all installation instructions.
- Make sure installation conforms to all applicable Local, State, and Federal Codes, Rules, and Regulations; such as State and Federal OSHA Regulations and Electrical Codes.
- Carefully check the unit for correct initial function.
- Read and follow the safety instructions. Keep them readily available for machine operators.
- Make certain all operators are properly trained, know how to safely and correctly operate the unit, and are properly supervised.
- Allow unit operation only with all parts in place and operating safely.
- Carefully inspect the unit on a regular basis and perform all maintenance as required.
- Service and maintain the unit only with authorized or approved replacement parts.
- Keep all instructions permanently with the unit and all decals/labels/notices on the unit clean and visible.
- Do not override safety features.

## Operator Protective Equipment

Personal protective equipment helps make tire servicing safer. However, equipment does not take the place of safe operating practices. Always wear durable work clothing during tire service activity. Loose fitting clothing should be avoided. Tight fitting leather gloves are recommended to protect operator's hands when handling worn tires and wheels. Sturdy leather work shoes with steel toes and oil resistant soles should be used by tire service personnel to help prevent injury in typical shop activities. Eye protection is essential during tire service activity. Safety glasses with side shields, goggles, or face shields are acceptable. Back belts provide support during lifting activities and are also helpful in providing operator protection. Consideration should also be given to the use of hearing protection if tire service activity is performed in an enclosed area, or if noise levels are high.

## Definitions of Hazard Levels

Identify the hazard levels used in this manual with the following definitions and signal words:

### DANGER

Watch for this symbol:



It Means: Immediate hazards, which will result in severe personal injury or death.

### WARNING

Watch for this symbol:



It Means: Hazards or unsafe practices, which could result in severe personal injury or death.

### CAUTION

Watch for this symbol:



It Means: Hazards or unsafe practices, which may result in minor personal injury or product or property damage.



Watch for this symbol! It means BE ALERT! Your safety, or the safety of others, is involved!

## Safety Notices and Decals



**Failure to follow danger, warning, and caution instructions may lead to serious personal injury or death to operator or bystander or damage to property. Do not operate this machine until you read and understand all the dangers, warnings and cautions in this manual. For additional copies of either, or further information, contact:**

**Hennessy Industries, Inc.**

1601 JP Hennessy Drive  
LaVergne, TN 37086-3565  
(615) 641-7533 or (800) 688-6359  
[www.ammcoats.com](http://www.ammcoats.com)

## Standard Safety Devices

- STOP key for stopping the wheel under emergency conditions.
- A hood guard of high impact plastic that is designed to prevent the counterweights from flying out in any direction except towards the floor.
- A hood switch interlock system that prevents the machine from starting if the guard is not lowered and stops the wheel whenever the guard is raised.

# Table of Contents

<b>Important Safety Instructions</b> .....	<b>ii</b>	Balancing Set-up Screen .....	13
Owner's Responsibility.....	iii	Special Functions Screen .....	14
Operator Protective Equipment.....	iii	Printer Screen.....	14
Definitions of Hazard Levels.....	iii	<b>Mounting Wheel on Spindle Shaft</b> .....	<b>14</b>
Safety Notices and Decals .....	iv	Standard Back Cone Mounting.....	14
Standard Safety Devices .....	iv	Standard Front Cone Mounting .....	15
<b>Setup Instructions</b> .....	<b>2</b>	Alternate Mounting .....	15
Receiving.....	2	Pneumatic Shaft (PL Version Only) .....	15
Electrical Requirements .....	2	<b>Setting Wheel Dimensions (DIM)</b> .....	<b>16</b>
Air Supply Connection.....	2	Definition of Dimensions (DIM).....	16
Machine Set-up .....	3	Wheel Data Entry .....	16
Floor and Space Requirements .....	3	<b>Balancing A Wheel</b> .....	<b>18</b>
Connect to Power.....	3	Dynamic Balancing .....	18
<b>Specifications</b> .....	<b>4</b>	Static Balancing .....	18
<b>Features</b> .....	<b>4</b>	<b>Attaching Corrective Weights</b> .....	<b>19</b>
<b>Balancing Your First Tire</b> .....	<b>5</b>	Measurement Result.....	19
<b>Principle Operating Parts</b> .....	<b>6</b>	Measurement Result Screen Options.....	19
Know Your Unit .....	6	Behind Spoke .....	20
Power Switch.....	7	Indicate Exact Corrective Weight Position .....	21
Using The Offset Arm.....	7	<b>Match Balance (Optimization)</b> .....	<b>22</b>
Using The Laser Locator .....	7	Match Balance (Optimization).....	22
Wheel Guard .....	7	Sonar LR Instruction.....	24
Positioning Pedal .....	7	<b>Calibration Program</b> .....	<b>25</b>
Auto Wheel Lock Feature (PL Version Only) .....	7	Arm Calibration.....	25
Control Panel .....	8	Machine Calibration.....	25
<b>Balancer Function Set-up and Review</b> .....	<b>9</b>	<b>Diagnostic Procedures</b> .....	<b>25</b>
Video Screen Flowchart.....	9	After Balance Vibration Problems .....	25
Screen-Saver Mode.....	9	<b>Troubleshooting</b> .....	<b>26</b>
Home Screen .....	10	<b>Maintenance Instructions</b> .....	<b>28</b>
User Memory .....	10	<b>Glossary</b> .....	<b>28</b>
Menu Screen.....	11		
General Set-up Screen .....	12		

	 <span style="font-size: 24pt; font-weight: bold; margin-left: 10px;">NOTICE</span>
	<p style="text-align: center; margin: 0;"><b>Read entire manual before assembling, installing, operating, or servicing this equipment.</b></p>

## **Set-up Instructions**

### **Receiving**

The shipment should be thoroughly inspected as soon as it is received. The signed bill of lading is acknowledgement, for the carrier, of receipt in good condition of the shipment covered by our invoice.

If any of the goods called for on this bill of lading are shorted or damaged, do not accept them until the carrier makes a notation of the shorted or damaged goods on the freight bill. Do this for your own protection.

NOTIFY THE CARRIER AT ONCE if any hidden loss or damage is discovered after receipt and request him to make an inspection. If the carrier will not do so, prepare an affidavit to the effect that you have so notified the carrier (on a certain date) and that he has failed to comply with your request.

IT IS DIFFICULT TO COLLECT FOR LOSS OR DAMAGE AFTER YOU HAVE GIVEN THE CARRIER A CLEAR RECEIPT.

File your claim with the carrier promptly. Support your claim with copies of the bill of lading, freight bill, invoice, and photographs, if possible.

Although COATS responsibility ceases upon delivery of the shipment to the carrier, we will gladly assist in tracing lost shipments. Our willingness to assist in every possible manner does not make COATS responsible for collection of claims, or replacement of lost or damaged materials.

### **Electrical Requirements**

See serial tag for the appropriate power requirements of your machine.

Always have a qualified electrician install the proper receptacles in accordance with state and local codes.

### **Air Supply Connection**

The wheel balancer requires a minimum 8 CFM clean/dry air source at 115 PSI. This system is only intended for operation of the spindle with pneumatic locking. The connection fitting is located at the back of the machine. At least 8 Kg/cm<sup>2</sup> (~ 0.8 MPa; ~ 8 BAR; ~ 115 PSI) pressure is needed for correct operation of the release device.

## Machine Set-up



**Do not use the control panel, control panel base, accessory storage, faceplate, hood or shaft to lift the balancer.**



**Do not attempt to install and set-up the unit yourself. Contact COATS as noted below.**

A factory trained COATS Service Technician must perform the install, set-up, and initial test procedures on your wheel balancer. Do not attempt to install and set-up the unit yourself. Accurate and reliable operation of your unit depends on proper installation. Please contact COATS directly at 1-800-688-9240 for the Certified Service Partner nearest you.

## Floor and Space Requirements

The balancer must be located on a flat floor of solid construction, preferably concrete. The balancer must sit solidly on its three feet. If the balancer is not level, does not sit solidly on its three feet, or is placed on an unstable floor, the balancer will not function properly and may produce inaccurate balance readings.

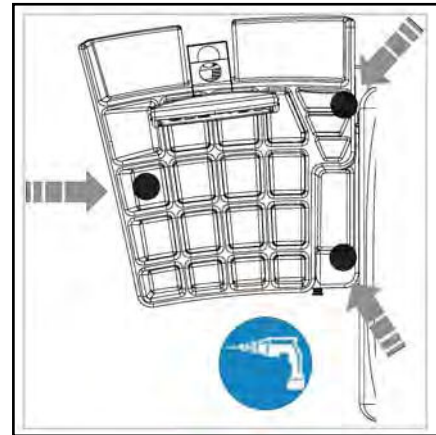

Do not operate the balancer while it is on the pallet.

Select a location for the balancer that provides a level, solid floor, and adequate clearance around and above the balancer. Make sure the location selected has enough room above and behind the unit so the hood can be raised completely. The location must also provide working room for mounting and removing wheels. Make sure the area has adequate lighting.

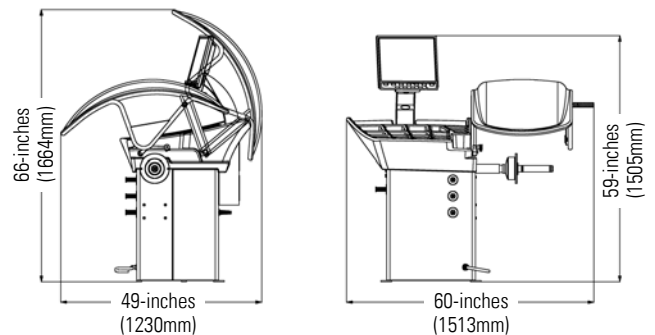

## Connect to Power

Your factory trained COATS® Service Technician should do the final check to verify the power installation before connecting the balancer to a power supply. Failure due to improper power connection may void the warranty.

## Specifications

### Wheel Diameter Range

10 - 30 inches (264 - 762 mm)

### Wheel Width Range

2 - 19 inches (51 - 483 mm)

### Maximum Outside Tire Diameter

Up to 42 inches (1067 mm)

### Maximum Tire/Wheel Weight

160 pounds (73 Kg)

### Mounting Shaft Diameter

40 mm

### Resolution (Round Off Mode)

0.25 ounce, position 1.40 degrees

### Resolution (Non-Round Off Mode)

0.01 ounce, position 1.40 degrees

### Balancing Display Increments

0.25 or 0.01 ounces

### Electrical Requirements

115V, 1 Ph, 50/60 Hz, 15A

NEMA L5-15P

(use grounding type plug)

### Air Source Requirement (PL Version Only)

115-145 PSI (8-10 Bar)

(air line water separator required)

### Footprint

Width: 44.5 inches (1130 mm)

Depth: 48.5 inches (1230 mm)

Height: 65.5 inches (1664 mm)

### Shipping Weight

275 pounds (125 Kg)

(without accessories)

## Features

- 3-D Auto Data Entry
- Simple, Interactive User Interface
- Auto Hood Start
- Static-On-Screen™ Display
- Direct Tape-A-Weight® Application
- Pneumatic Mounting (Option)
- Radial Runout Measurement
- Lateral Runout Measurement (Option)
- Static, Dynamic And Multiple Tape-A-Weight®
- Laser Guided Operation™



## ★Balancing Your First Tire

### 1. Turn the machine OFF then ON.

The machine wakes up at the Home Screen using standard clip-on wheel weight locations (Clip 1 & Clip 2) and wheel dimensions.

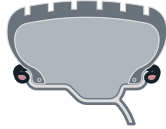

### 2. Mount a tire/wheel onto balancer that will use standard clip-on wheel weights.

Use the most appropriate mounting method.

### 3. Always remove any weights already attached to the wheel.

### 4. Use offset arm to enter A & D wheel dimensions automatically.

Pull offset arm out to the wheel, hold it still at clip-on weight position against wheel flange, and wait for BEEP. Return arm to home position.

Clip-on Weight Location — viewed on a cut-away rim for clarification.

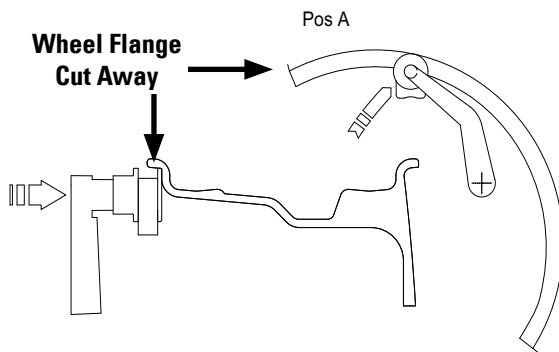

Figure 1 - Clip-On Weight Location

### 5. Lower wheel guard to enter W wheel dimension automatically.

### 6. With hood lowered; wheel spins and out of balance values are measured and displayed.

The corrective weight amount appears on the video display for inboard and outboard weight locations.

### 7. Raise hood after tire stops rotating.

Wait for wheel to stop before raising the wheel guard.

### 8. Turn wheel in direction of inboard arrow until this symbol appears:

Note: If an inboard corrective weight is not required the measurement will read - - -, go to step 10.



### 9. Attach inboard corrective weight.

Attach specified weight amount at top-dead-center on inside flange of wheel (clip 1).

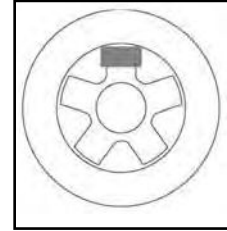

### 10. Turn wheel in direction of outboard arrow until this symbol appears:

Note: If an outboard corrective weight is not required the measurement will read - - -, go to step 12.



### 11. Attach outboard corrective weight.

Attach specified weight amount at top-dead-center on outside flange of wheel (clip 2).

### 12. Lower hood to respin the tire/wheel and check balance.

The weight readings should now be - - -.

Note: Throughout this manual tire dimensions are referred to as A, W, and D, see figure 2.

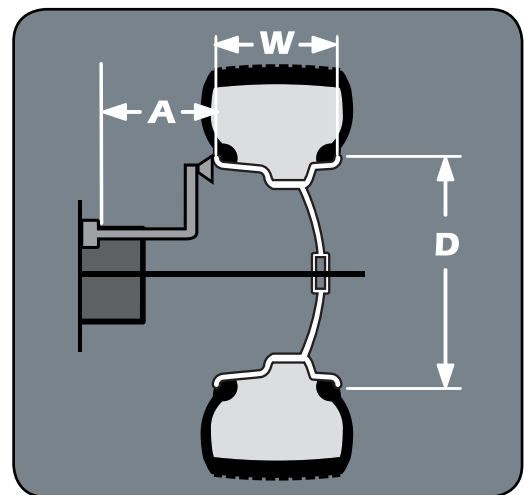

Figure 2 - A, W, and D Tire Dimensions

## Principle Operating Parts

### Know Your Unit

Compare this illustration with the unit before placing it into service. Maximum performance and safety will be obtained only when all persons using the unit are fully trained in its parts and operation. Each user should learn the function and location, of all controls.

Prevent accidents and injuries by ensuring the unit is properly installed, operated and maintained.



**A** - Video Screen

**B** - Control Panel

**C** - Plug (Back Of Machine)

**D** - Connect To Air (Back Of Machine, PL Version Only)

**E** - ON/OFF Switch

**G** - Storage Pegs

**H** - Hood Guard

**J** - Hood Sonar - Width Sensor

**K** - Weight Tray with Pockets for Weights

**L** - Offset Arm, Measures A & D of Tire/Wheel (Shown In Home Position)

**M** - Lateral Runout Sensor (Optional)

**N** - Positioning Pedal (Release Pedal On Pneumatic)

**O** - Radial Runout Sensor

**P** - 40 mm Shaft (Pneumatic Shaft Optional)

**R** - Laser Locator

**Note:** Throughout this manual, wheel weights are referred to as Clip-on or Tape-A-Weight®. Figure 3 shows an example of each weight.



Figure 3 - Corrective Weight Examples. For Best Results, use BADA® Brand Wheel Weights.

### Power Switch

The ON/OFF switch location (figure 4) is on the left side of the balancer; below the weight tray.

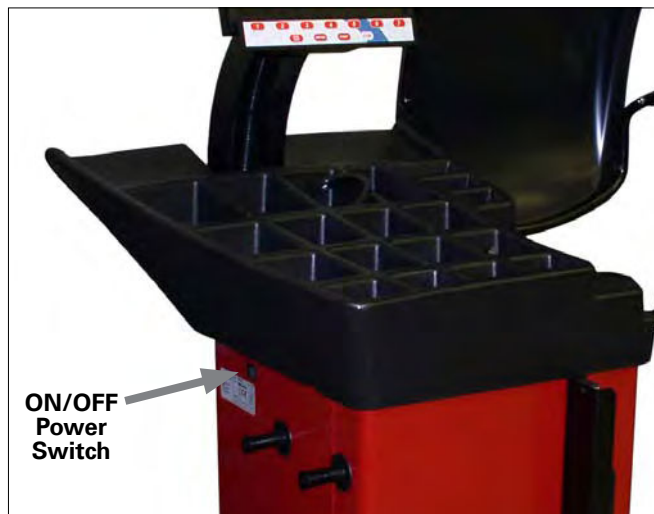

Figure 4 - On/Off Switch

### Using The Offset Arm

Use the offset arm gauge to automatically measure the distance from wheel to machine and the wheel diameter at the point of weight application. Also, use the offset arm for the correct positioning of weight application on the inside rim as indicated by the balancer instructions. When not in use or when prompted by the balancer instructions, store the offset arm in the home position as shown in figure 5.

### Using The Laser Locator

If a hidden weight (Tape-A-Weight®) location is selected, use the laser locator (figure 5) to point to the hidden weight location.

**Note:** For best performance, choose an outboard weight position as deep into the rim as wheel allows.

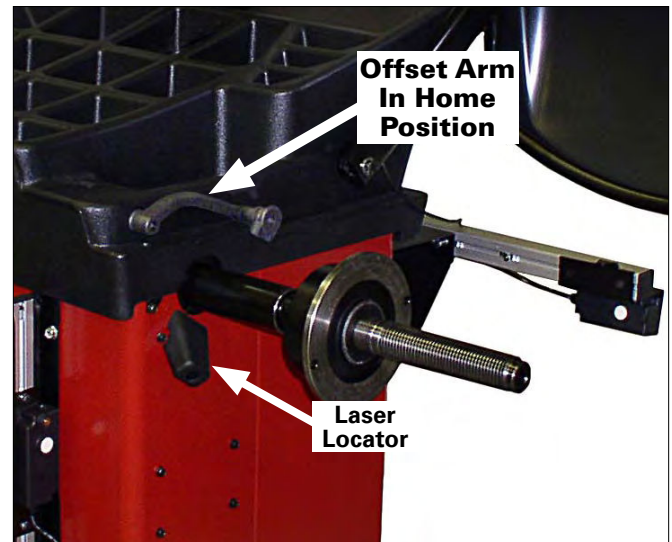

Figure 5 - Location of Offset Arm (Stored In Home Position) and Laser Locator

### Wheel Guard



**Never raise up the wheel guard before the wheel has come to a stop. Keep hair, loose clothing, fingers and all parts of body away from moving parts.**

If, due to a fault in the machine, the wheel keeps spinning permanently, switch off the machine at the master switch or by unplugging the plug from the power supply. Wait until the wheel stops, or actuate the positioning pedal before opening the wheel guard.

### Positioning Pedal

In the standard version, the pedal controls a mechanical brake which facilitates positioning and holding the wheel in place for corrective weight application.

In the pneumatic version, the pedal engages/releases the pneumatic sleeve. The pedal has two positions: the upper position releases the pneumatic sleeve; the lower position engages the pneumatic sleeve to mount the wheel onto the pneumatic shaft.

### Auto Wheel Lock Feature (PL Version Only)

Once the assembly is rotated to the weight application position, it will lock in place to assist in weight placement. Simply apply additional force and the lock will release to allow movement to the next weight position.

## Control Panel

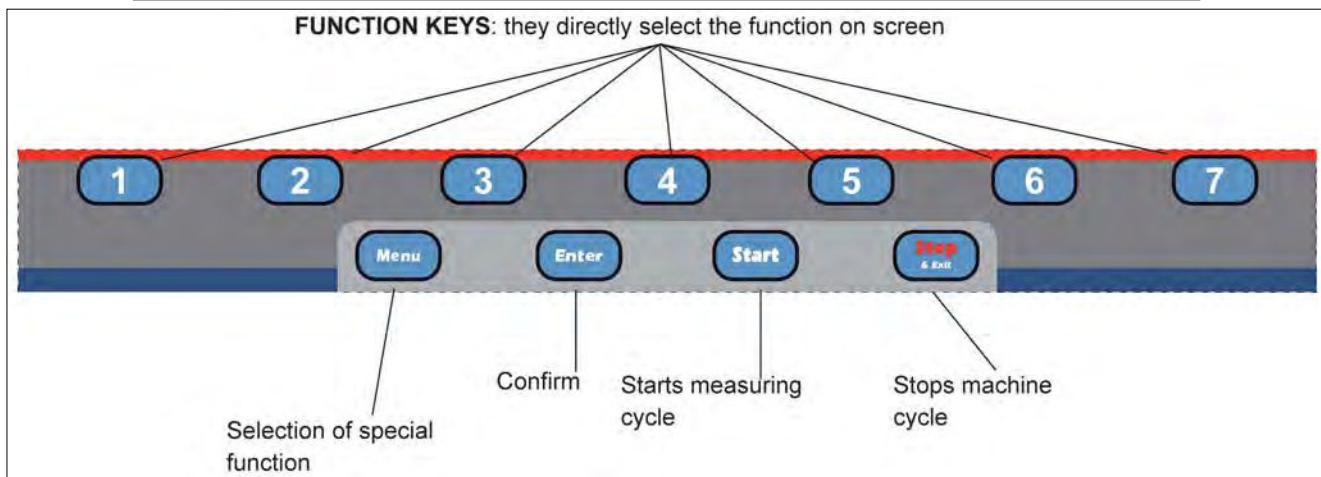

To enter a function, press the appropriate function key. Note that the balancer monitor is not a touch screen type (figure 6).

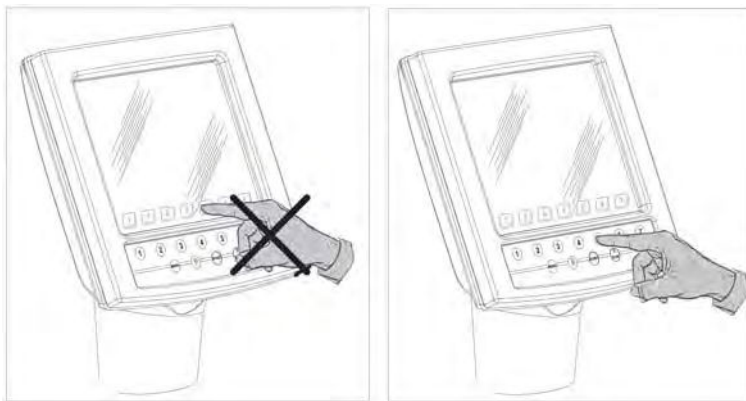
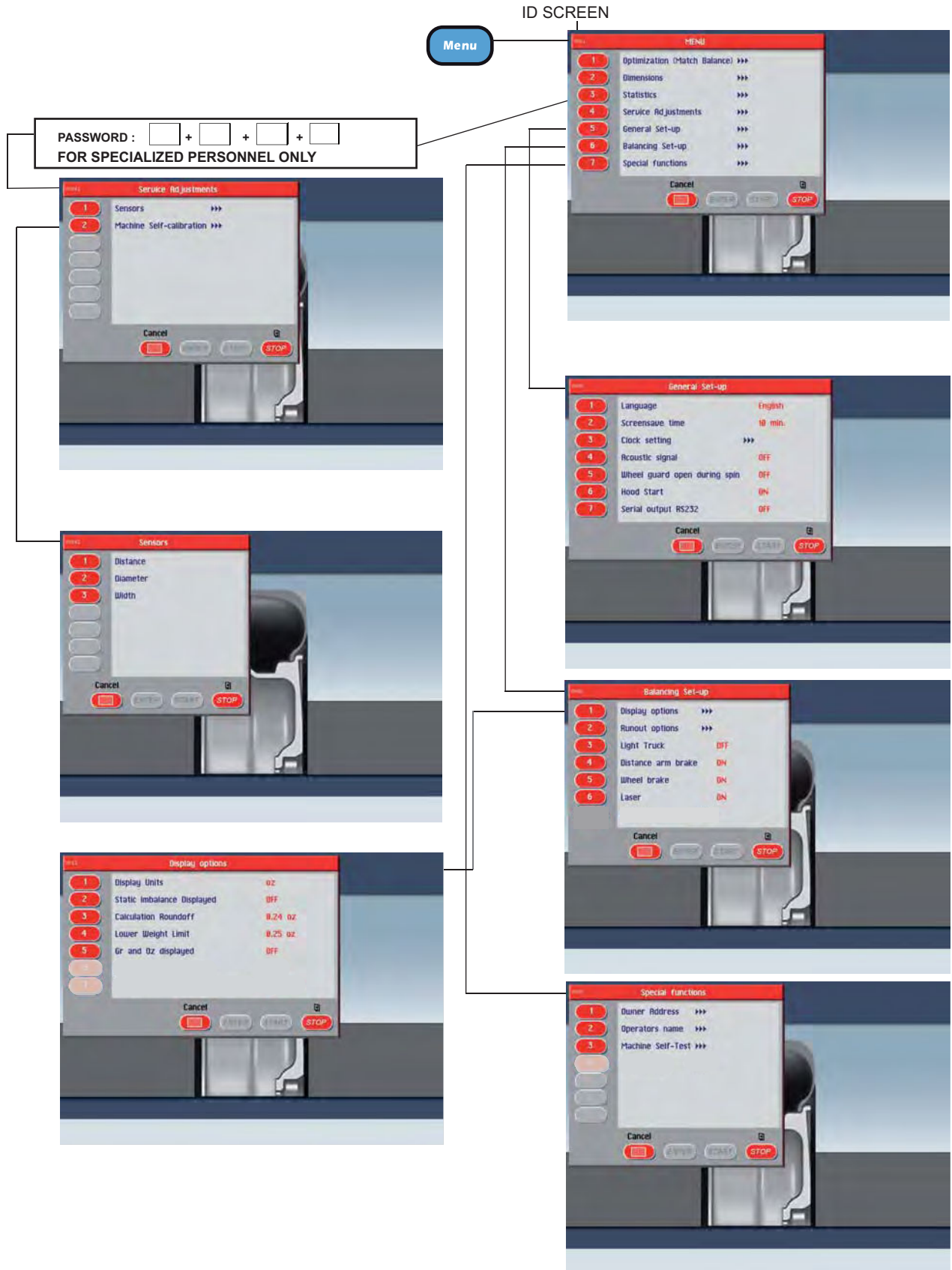

Figure 6 - Press Control Panel Function Keys

**Note:** Only press buttons with your fingers. Never use the weight hammer or other pointed objects to press buttons.

# Balancer Function Set-up and Review

## Video Screen Flowchart



## Screen-Saver Mode



If the machine remains on the initial screen for a certain amount of time without being used, the system automatically switches to a screen-saver. In most cases, to reactivate the initial screen, just mount a wheel, rotate the wheel or press a key to provide the input to wake the balancer back up.

## Home Screen

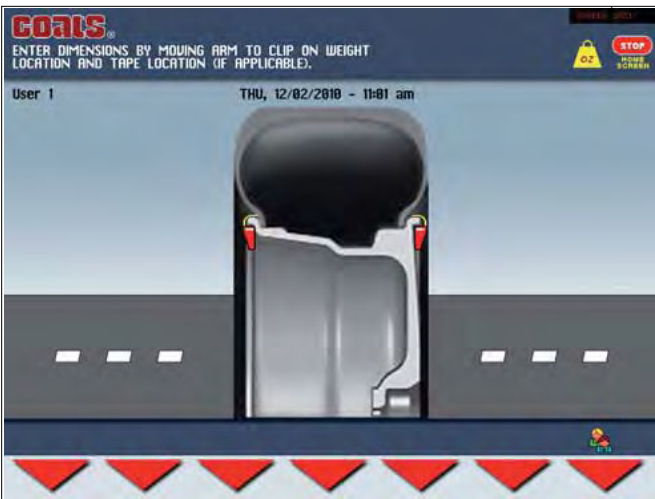

Buttons enabled:

**Menu**

Access the balancer's main functions screen.

**7 User**

Select to access user memory functions.

**Start**

Press to spin assembly.

## User Memory



Use the wheel balancer simultaneously by four different users who, through a simple sequence, can memorize their work condition and call it up when needed. To enter in a user name access the special functions screen and select the operator name option.

Buttons enabled:

**1 User**

Select a user into current program memory.

**2 Load User**

Select to recall a user's memorized work condition.

**3 Save User**

Select to memorize the current user's work condition.

**Note:** The dimensions memorized as USER are lost when the machine is switched off.

**Note:** The current USER is always displayed in the measurements and dimensions screens.

## Menu Screen



The menu screen provides you with many possibilities for accessing programs and presetting the machine according to your requirements. These settings remain unaltered even when the machine is switched off.

Buttons enabled:



### Menu

Return to previous window



### Stop & Exit

Return to Result screen



### 1 Optimization (Match Balance)

Select this mode to access the optimization program. See Optimization (Match Balance).



### 2 Dimensions

Access this screen to view the tire/wheel dimension measurements. See Setting Wheel Dimensions (DIM).



### 3 Statistics

Machine spins/day	Left	Right	TOTAL
0.25	0	0	
0.50	2	2	
0.75	2	1	
1.00	0	0	
1.25	0	0	
1.50	0	0	
1.75	2	0	
2.00	1	0	
2.25	1	0	
2.50	0	0	
2.75	2	0	
3.00	0	1	
TOT. all	15.75	4.75	
TOT. 0	10	4	

Machine Spins/day - Indicates the number of spins from the first time the machine is turned on for the day. When the machine is turned off, this parameter remains stored until the date changes (a new day).

Daily Weight Statistics - Each horizontal line indicates the number of clip-on and adhesive weights used to balance the wheels.

- Tot g (tot oz): indicates the daily weight value of the clip-on and adhesive weights used to balance the wheels.
- Tot n: indicates the daily number of clip-on and adhesive weights used to balance the wheels.

Under statistics the following buttons are enabled:



### 1 Reset

Resets the daily statistics or resets the total statistics (in this case, a keyword must be entered).



### 2 Total

Goes to the total statistics frame containing the same information as the daily statistics but referring to the time interval between the two dates displayed.



### 6 Print

Prints the daily/total statistics (option).



### 7 Exit

Return to the previous screen.



### 4 Service Adjustments

In order to gain access to the "Reserved Calibrations and Functions" it is necessary to enter a password. Any incorrect operation within the functions described below could impair the operation of the wheel balancing machine. Unauthorized use will cause cancellation of the warranty on the machine.



### 5 General Set-up

Select this to access the General Set-up screen.



### 6 Balancer Set-up

Select this to access the Balancing Set-up screen.



### 7 Special Functions

Select this to access the Special Functions screen.

## General Set-up Screen



The general set-up screen provides you with many possibilities for presetting the machine according to your requirements. These settings remain unaltered even when the machine is switched off.

*Buttons enabled:*

### **Menu**

Return to previous window

### **Stop & Exit**

Return to Result screen

### **1 Language**

Access this function to select the language you want for displaying descriptive and diagnostic messages regarding machine operation.

### **2 Screensave Time**

If this function is enabled, the screensaver automatically activates when the machine is not used for a certain period of time. You disable this function by setting it to 0 min.

### **3 Clock Setting**

Use to set the correct date and time. Follow the instructions on screen.

### **4 Acoustic Signal**

When ON is selected, the sending of an acoustic signal (beep) is enabled in the following cases:

- when any push button is pressed.
- when dimensions are acquired in automatic mode.
- when the correct angular position for weight application is reached in the result screen.
- when the correct angular position for weight application is reached in the position repeater screen.

### **5 Wheel Guard Open During Spin**



**Never raise up the wheel guard before the wheel has come to a stop. Keep hair, loose clothing, fingers and all parts of body away from moving parts.**

Select the ON option to enable opening of the guard (when the motor is off) during a spin. If the guard is opened when the motor is on, error 5 (guard open) is displayed. If OFF is selected, an error 5 (guard open) will always signal when the guard is opened.

### **6 Hood Start**

Select the ON option to enable the automatic start of the spin when the guard is closed.

### **7 Serial Output**

This option enables/disables the sending of the measured out of balance and phase values to serial output RS232C.



## Balancing Set-up Screen



The balancing set-up screen provides you with many possibilities for presetting the machine according to your requirements. These settings remain unaltered even when the machine is switched off.

*Buttons enabled:*

### **Menu**

Return to previous window

### **Stop & Exit**

Return to Result screen

### **1 Display Options**

*Under display options the following buttons are enabled:*

#### ➤ **1 Display Units**

Select whether to display the out of balance values in grams, ounces or both.

#### ➤ **2 Static Imbalance Displayed**

Enable/disable Static on Screen™ display. You can always select the static frame by pressing the button from the result screen.

#### ➤ **3 Calculation Roundoff**

Scroll through to set a weight correction roundoff value. Typically you would set it around 0.25 ounces (7 g) for most wheels and around 0.50 ounce (14 g) for heavy wheels.

#### ➤ **4 Lower Weight Limit**

The out of balance threshold below which - - -, instead of the out of balance value, appears on the screen at the end of a measurement cycle. Note that the closer you set the lower limit to 0.13 ounces (4 g) the more respins you will have when attaching a 0.25 ounce (7 g) weight.

### **2 Runout Options**

*Under runout options the following buttons are enabled:*

#### ➤ **1 Radial Runout Displayed**

The radial runout value display on the main screen.

#### ➤ **2 Runout Diagnosis**

Enable/disable automatic runout diagnosis screen at the end of spin.

#### ➤ **3 Runout Measuring Unit**

Select whether to display runout values in mm or inches.

#### ➤ **4 Max True Runout Limit**

Set a desired tolerance that indicates the limit of runout allowed on the tire/wheel before it is suitable to match balance.

#### ➤ **5 Rim Runout Limit**

Set a desired tolerance that indicates the limit of runout allowed on the rim before it is suitable to match balance.

#### ➤ **6 Correction Runout Limit**

Set the minimum correction limit tolerance obtainable below which it is not considered appropriate to match balance.

### **3 Light Truck Mode**

The default is OFF. Scroll to set a value of 1", 1.5" or 2". This is only necessary if a tire/wheel assembly requires an adjustment to the automatic width measurement value, where the actual tire width value is greater than (extends beyond) the actual rim width value.

### **4 Offset Arm Locking**

Enable/disable distance gauge locking when the correct distance is reached to apply the adhesive weight to correct the out of balance. To release the offset arm, lower it to below 10-inch diameter.

## 5 Wheel Locking

Enable/disable wheel locking in the weight correction position. Operational only on PL version balancer.

The possible options are:

OFF: disabled

ON: enabled

ALUS: enables wheel locking in position for the ALUS correction mode only.

## 6 Laser

Enable/disable laser for adhesive weight positioning. Note that offset arm locking will not be enabled when laser is activated.

## Special Functions Screen



Buttons enabled:

## 1 Owner Address

This information appears on the screensaver.

## 2 Operators Name

Enter up to four different machine user names. Follow the on-screen instructions to complete the customizing.

## 3 Machine Self-test

Self-diagnostic screen is provided for easier troubleshooting.

## Mounting Wheel On Shaft

Select the most appropriate mounting method for the wheel you are balancing. Using the proper method ensures secure mounting and safe balancer operation, and prevents damage to the wheel.

On most wheels, the inner side of the wheel hub usually has the most uniform surface for wheel balancing. Always center the wheel by the most uniform shaped side of the hub to achieve the most accurate balance.

Regardless of mounting type, on standard units, always make sure that the wheel is forced firmly against the shaft faceplate and that the hub nut engages the threaded shaft for at least four complete turns. To assist in centering the wheel properly, rotate the wheel and the shaft while tightening the hub nut.



**Failure to tighten the hub nut properly may result in the wheel dismounting, causing personal injury and property damage.**

## Standard Back Cone Mounting

Most original equipment and steel wheels can be mounted properly using this method. The wheel is centered on a cone from the inner side of the hub.

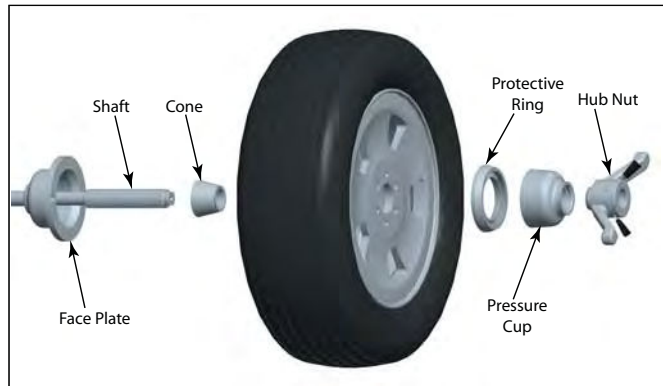

Figure 7 - Standard Back Cone Mounting

**1.** Select the cone that best fits the center hole in the wheel. Slide the cone onto the shaft with the large end towards the faceplate.

**2.** Lift wheel onto the shaft and center it on the cone.

**3.** Attach the pressure cup to the hub nut and install the assembly onto the shaft. Tighten securely.

**Note:** Use a nylon spacer (no mar ring) to protect custom wheel finishes.

**4.** Thread the hub nut onto the shaft, and tighten it against the wheel. The wheel must be forced firmly against the faceplate. The hub nut must engage the threads for at least four full turns.

**Note:** If the hub nut will not tighten completely, use the front cone mounting method.

## Standard Front Cone Mounting

A wheel should be centered by the outer side of the hub only when the inner surface will not provide an accurate surface to center on.



Figure 8 - Front Cone Mounting

1. Select the cone that best fits the center hole in the wheel.
2. Lift the wheel onto the shaft and slide it back against the shaft faceplate.
3. Slide the cone onto the shaft and into the center of the wheel. You will need to lift the tire to seat the cone in the center hole.
4. Install the hub nut (without pressure cup) onto the shaft. Tighten it securely against the cone. The hub nut must engage the threads for at least four full turns.

**Note:** If the hub nut will not tighten completely because of a lack of threads, use an additional cone as a spacer between the mounting cone and the hub nut. The wheel must be forced firmly against the faceplate.

## Alternate Mounting

If the wheel has a protruding outer hub which will not permit the use of the pressure cup, or the cup will not permit the hub nut to engage at least four turns of the shaft, this alternate method should be used.

1. Select the cone that best fits the center hole in the wheel. Slide the cone onto the shaft with the large end towards the faceplate.
2. Lift the wheel onto the shaft and center it on the cone.
3. Use the small nylon spacer (no-mar ring) or a centering cone to press against the outer wheel hub.
4. Install the hub nut (without the pressure cup) onto the shaft. Tighten securely.

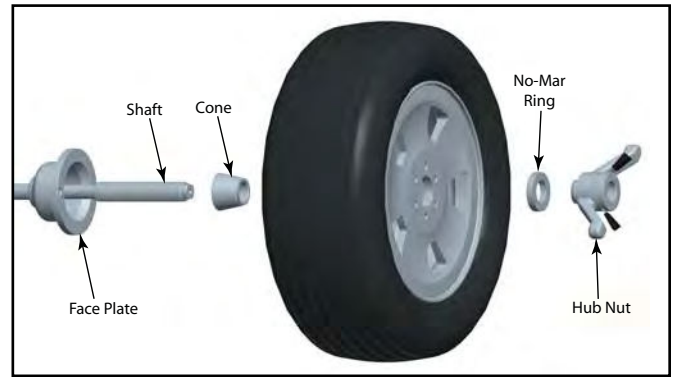

Figure 9 - Alternate Mounting

## Pneumatic Shaft (PL Version Only)

Use the most appropriate mounting method for the wheel, but instead of using a hubnut use the pneumatic sleeve. When the pneumatic sleeve is in place, press down on the positioning pedal to mount the wheel on the shaft.

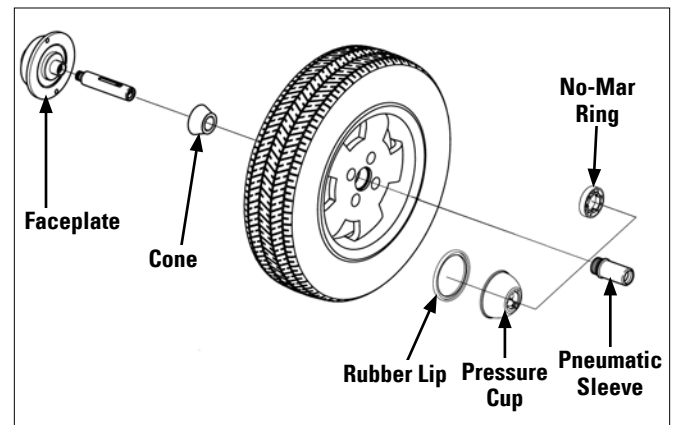

Figure 10 - Pneumatic Mounting

**Important:** Always be sure to remove the wheel assembly from the pneumatic shaft before disconnecting the air supply from the machine.

## Setting Wheel Dimensions (DIM)

Before a wheel can be balanced, wheel dimensions must be entered into the computer.

### Definition of Dimensions (DIM)

#### W = Width

The width of the wheel at the rim flanges, measured with the calipers or width sonar as shown in figure 17.

#### D = Diameter

The diameter of the wheel as indicated on the tire.

#### A = Offset

The distance measured from the balancer ("0" on offset arm) to inner plane of the rim (inner weight location).

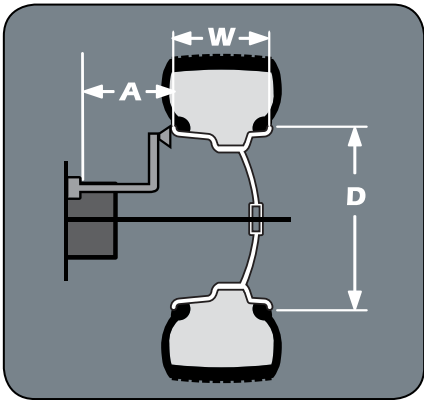

Figure 11 - W, D, and A Tire Dimensions

**Note:** Only use calipers provided by the wheel balancer manufacturer because others may not be the same.

**Note:** A thick flange, on some aluminum wheels, can effect the measured diameter. For example, a 16-inch rim can have a measured diameter of 15.5-inches.

#### A2 = Offset

The distance measured from the balancer ("0" on offset arm) to outer plane of the rim (outer weight location). Used only for adhesive weight location.

#### D2 = Diameter

The diameter as measured at the A2 weight location. Used only for adhesive weight location.

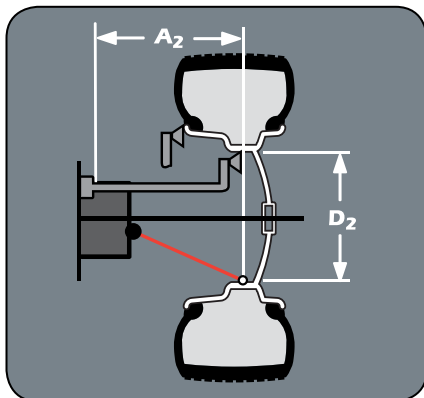

Figure 12 - A2 and D2 Tire Dimensions

## Wheel Data Entry

**1.** To automatically enter A & D dimensions, pull the offset arm out and up against the wheel at the appropriate weight placement location; hold it still and wait for the deep or the display to change.



Figure 13- Dimensions Screen

**Note:** When the offset arm is pulled out from home position, the dimensions screen is automatically selected.

**Note:** If the acoustic signal is enabled, the acquisition of the dimensions is accompanied by a BEEP.

**Note:** When the computer acquires the wheel dimensions it is indicated by the correction weight symbol, which changes from blue to red.

### Automatic A & D Measurement Methods:

- For Clip 1 data entry, move the arm from home position and place the offset arm up against the wheel flange in either position 1 or 2, as shown in figure 14.

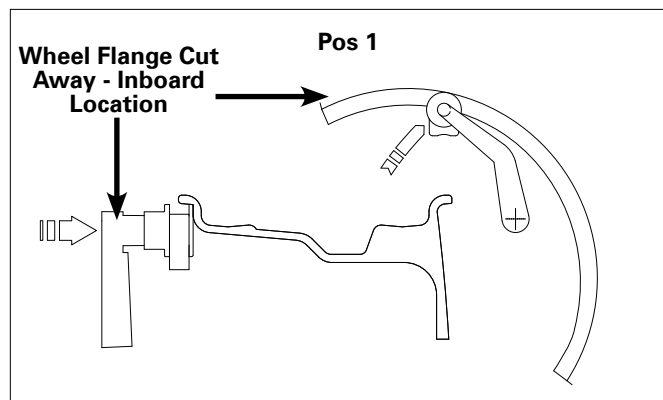

Figure 14 - Automatic A & D Measurement At Clip 1 Weight Location

- For A1 data entry, move the arm from home position and place the offset arm up against the wheel flange in position A1, as shown in figure 15.
- For A2 data entry, after taking the inboard measurement, move the offset arm to the inner area of the wheel; up against the rim at the outboard weight placement location, as shown in figure 15.

**Important:** The A2 measurement must be at least 2-inches greater than the A1 measurement.

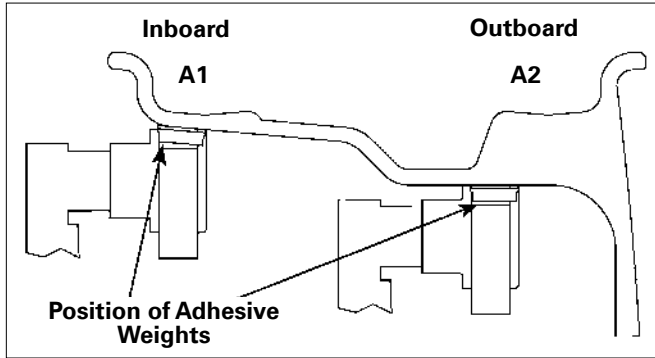

Figure 15 - Automatic A2 & D2 Measurement At Adhesive Weight Location

2. Return offset arm to home position.
3. Lower the hood guard to enter W wheel data automatically.

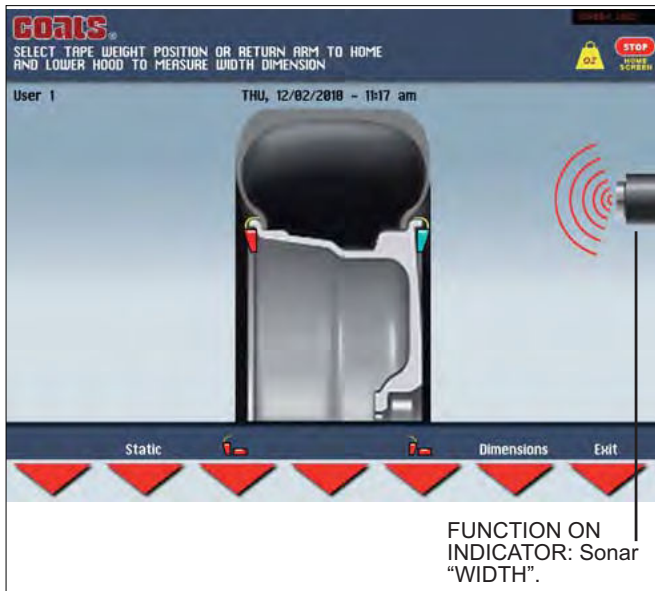

Figure 16 - Automatic W Measurement

**Note:** After wheel data entry, use the **3** key to select the inboard plane correction type for ALUS.

*Dimension screen buttons enabled:*  
 - automatic width measurement  
 - automatic ALUS wheel measurement  
 are:

**2 Static / Dynamic**

Toggle between Dynamic and Static balancing.

**3 Weight Type Selection**

Select either clip or adhesive weight for inboard plane.

**5 Weight Type Selection**

Only for automatic width: select either clip or adhesive weight for outboard plane.

**6 Dimensions**

Select the manual dimension presetting screen.

**7 Exit**

Return to Result screen

**Stop & Exit**

Return to Home screen

**Start Spin Wheel**

When hood guard is lowered wheel spins and out of balances are measured

**Note:** When manually entering W, use the plastic calipers provided with the wheel balancer to measure the wheel width, as shown in figure 17. Enter the W dimension to match the measured caliper width of the mounted rim.



Figure 17 - Caliper Placement On Wheel

**Note:** You must manually input wheel dimensions for any wheel above a 24-inch diameter.

**Note:** On small diameter wheels, the mounting surface must be a minimum 7-inch diameter.

## Balancing A Wheel

A variety of wheel configurations can be balanced using this wheel balancer. Read through this section, it will help in determining which balancing options are best suited for certain wheel assemblies.

### Dynamic Balancing

Choose a dynamic balance to balance a wheel using two planes for correction. Select the weight option that best fits the available weight locations on the rim.

**Clip-on Weights** - The standard default; used for most passenger tire/wheel assemblies using the most common location for corrective weights. Clip-on weights are placed on the inner (inboard) and outer (outboard) rim flanges.

**ALUS (Aluminum Wheels)** - To balance aluminium wheels you usually use a self-adhesive weight location that is positioned differently from the clip-on weight location. Be sure to use the appropriate wheel data entry method since the balancer calculates out of balance values based on the wheel dimension measurements (DIM) entered for the tire/wheel assembly.

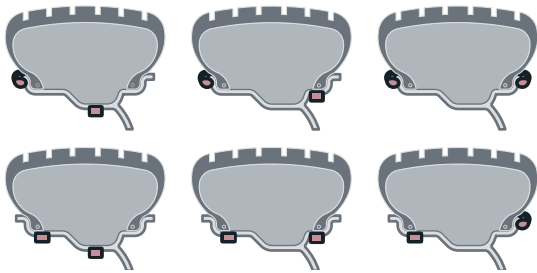

Figure 16 - Dynamic Balance Weight Locations

**Note:** When the machine is switched on, a standard dynamic balance using clip-on weight locations is the default setting.

### Static Balancing

Choose a static balance to balance a wheel using one plane for correction. Place the single corrective weight at top-dead-center (12 o'clock) on either flange, at the center of the rim channel, placed inward either side, or split on either sides.

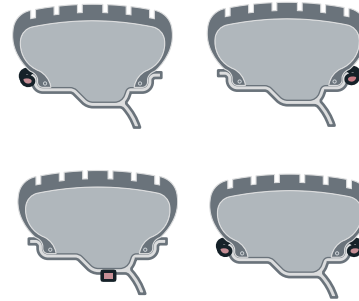

Figure 17 - Static Balance Weight Locations

**Note:** When in static mode, you only need to input the DIAMETER wheel measurement.

**Important:** If you decide to use the rim channel for corrective weight placement, remember you may need to adjust the DIAMETER measurement input. Typically you would make it 2 or 3 inches less than the actual tire/wheel diameter.

## Attaching Corrective Weights

### Measurement Result

After the wheel spins and out of balances are measured and displayed, the corrective weight amount appears on the video display for inboard and outboard weight locations. Arrows appear that are useful for positioning the corrective weight at the application point.

If the out-of-balance is less than the chosen threshold value, - - - appears instead of the out-of-balance value to indicate, on that particular side, that the wheel is in tolerance.



Figure 18 - Measurement Result Screen

**Laser OFF:** after positioning and locking the wheel, apply the weight vertically at 12 o'clock (top-dead-center).

The symbol  is shown on the screen.

**Laser ON:** apply the clip-on weights at 12 o'clock. If using adhesive weights, when the correction position is reached, the laser turns on indicating the point to apply the adhesive weight.

The symbol  is shown on the screen.

**Note:** If the acoustic signal is enabled, a BEEP will signal that the wheel is in position for corrective weight placement.

**Note:** If the wheel locking feature is enabled (see MENU), the wheel is automatically held in place for corrective weight placement.

## Measurement Result Screen Options

The following *buttons* are enabled:

### 1 Roundoff

Press to display the residual out of balance, with an accuracy of 0.1-ounce (0.5 g).

### 2 / 3 / 5 Correction Mode

After performing an automatic entry of wheel dimensions, select to place the correction weights as required.



Figure 19 - Weight Placement Screen

To display static out of balance, press the **2** button on the measurement screen (the inner side diameter is always considered).

**Note:** If, when an automatic measurement is taken for both planes, the difference between the inner and outer diameters is greater than or equal to 2 inches, the system sets the inboard side corrective weight. To modify this presetting, press the **3** button. The outboard side may only be "adhesive".

**Note:** When the mode is changed, the out of balance values are recalculated automatically on the basis of the previous spin. Simultaneous display of the Static out of balance always preset can be enabled through the special function in Set-up (STATIC OUT OF BALANCE DISPLAYED).

#### 4 Runout

Runout result screen.

#### 6 Behind Spokes

Enable split function of out of balance (see Behind Spokes).

#### 7 Indicate Exact Corrective Weight Position

If laser disabled, indicates and locks arm when in correct horizontal plane (see Indicate Exact Corrective Weight Position).

#### Menu Special Functions

Selection of special functions.

#### Start Balancing Spin

Lower hood, then spin wheel to check balance.

#### Stop & Exit

Return to Home screen

## Behind Spoke

“Splitting” weight is used to hide any adhesive weights behind the rim spokes.



Figure 20 - Behind Spoke Screen

Press button **6**

**LASER OFF:** to split the out of balance detected in two different positions, proceed as follows:

**1.** Position static out of balance or ALUS external side in the correction position and press button **6** :



**2.** Select a spoke close to the 12 o'clock position to be corrected, move it into the 12 o'clock position and press button **6** .

**3.** Turn the wheel in the rotation direction indicated on the out of balance display, bringing the second spoke to the 12 o'clock position and press button **6** .

Turn the wheel in direction of rotation.

Turn the wheel in reverse direction of rotation.

**4.** At this stage, the screen shows the graphic display of the correction spokes with the relative weight of the out of balance detected.

**5.** Position the spokes indicated on screen in the 12 o'clock position and correct with the value displayed.



**LASER ON:** to split the out of balance measured in two different positions, proceed as follows:

Position the static out of balance or outboard adhesive weight in the correction position and press button

**6** :



**1.** Turn the wheel and press the **6** button when the laser points to the spoke where the correction is to be made.

**2.** Release the **6** button.

**3.** Turn the wheel in the direction indicated on the display until the second spoke is in the position indicated by the laser and press the

**6** button.

**4.** At this point, two indications are shown on the screen to position the spokes for the out of balance correction.

**5.** Move the spokes indicated to the correction position and correct according to the value displayed.

**Important:** Always follow the information provided by the wheel to optimize correction.

**Note:** When SPLIT is enabled, the icon  appears on the left of the screen.

## Indicate Exact Corrective Weight Position

It is recommended that you always use this function to correct an out of balance using adhesive weights. Remember to thoroughly clean the application areas.

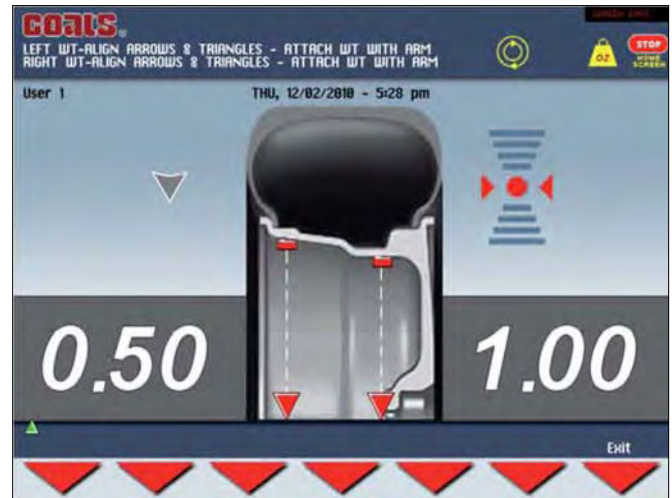

Figure 21 - Indicate Exact Corrective Weight Position Screen

**LASER OFF:** press button **7** on results screen.

Pull out the arm to position 1 as shown in figure 14 page 16:

**1.** Place a Tape-A-Weight™ onto arm.

**2.** Rotate assembly until the correction position is reached, indicated by:



**3.** Pull arm out until  aligns with  and the arm locks into position.

**4.** Rotate the arm to the correction position and apply the Tape-A-Weight™ onto the wheel.

**Note:** When the acoustic signal is enabled, reaching a fixed arrow  is accompanied by a BEEP.

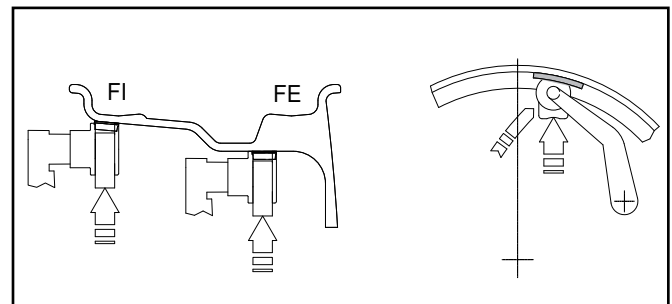

## Match Balance (Optimization)



**Match Balance involves the loosening of tire beads and the inflation of a tire. Training is necessary in tire changer operation and understanding the dangers involved during bead seating and tire inflation before attempting this stage of the Match Balance procedure. Read the operators manual supplied with the tire changer and consult a supervisor.**



### Match Balance (Optimization)

The symbol  is displayed automatically for static out of balance exceeding 30 grams (1.1 oz.)

Use the Match Balance (Tire/Rim Weight Optimization) program to determine the best mating of tire and rim that will result in the least amount of total out of balance of the assembly. It requires two spins and two rotations of the tire on the rim. Match Balance may be needed when:

- The customer complains of ride problems.
- The balancer calculates a high out of balance.
- The balancer calls for Total Static weights in excess of 3 ounces (85 grams) on passenger car tires.

Having performed a balancing spin:

Press  +  and follow the on-screen instructions.

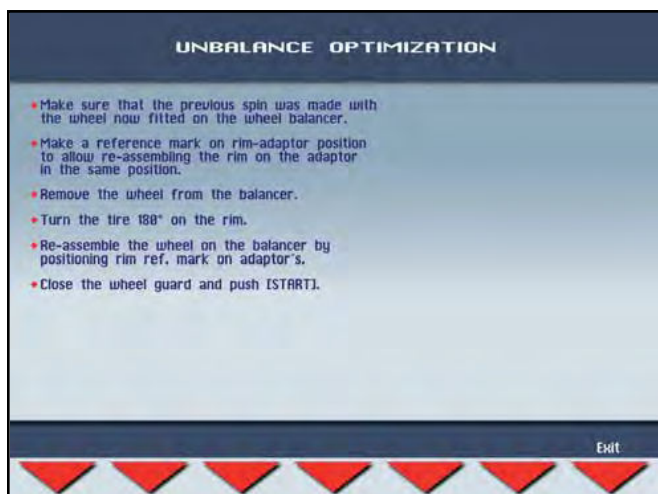

Figure 23 - Optimization

**Important:** A high out of balance may indicate the improper mounting of the assembly on the balancer, or a rim that is out of round or misformed, or a tire with a bubble or other problem. If the out of balance is excessive, it may be prudent to replace the rim, the tire, or both. If either is replaced, do not continue with Match Balance. Balance the new tire and rim and evaluate the readings.

If you choose to use Match Balance to correct for a condition, such as a large static out of balance, then follow the on-screen instructions for the MATCH BALANCE procedure as outlined in the following steps.

**Note:** Use this procedure only after the wheel has spun and the corrective weight amount is displayed.

**Note:** Presetting of tolerance on the machine. There is no general rule concerning acceptability of a Max True Runout Limit (see Balancing Set-up) value. As a first approximation we consider it correct to use a threshold of 1 to 1.5 mm.

The much enlarged figures show the outer tire surface and axis of wheel rotation.

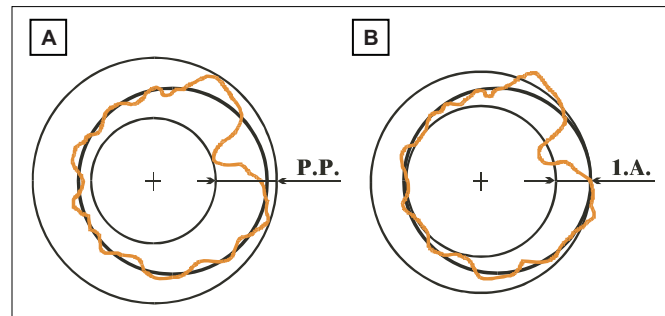

Figure 24 - Runout Measurements

Fig. A - shows measurement of the total Peak-to-Peak runout defined as maximum radial deviation of the tire surface.

Fig. B - shows measurement of the runout of the 1st harmonic, i.e. the eccentricity of that circle "recopies" the tire shape, by averaging the local deviations of the tire from the round shape.

Obviously the P.P. measurement is normally greater than that of the 1st harmonic. Tire manufacturers normally supply two different tolerances for the two eccentricities. The radial and lateral runout measurements are automatically carried out after the out of balance measurement without having to go into particular procedures. Remember to position the sonar sensors in front of the surface to be measured before pressing the

 button.

The maximum limit of the first harmonic can be set (MAX. TRUE RUNOUT LIMIT). When this limit is exceeded, the wheel balancer displays a warning and diagnostic frame indicating an eccentricity condition that needs to be corrected.



Figure 25 - Runout Diagnosis Screen

The following buttons are enabled:

**1 Graphics**

To display the graphs of the runout program.

**2 Match Balance**

To go into the Match Balance procedure.

**7 Result Screen**

To go to the result screen (the symbol above the button

**4** is displayed in yellow to indicate an excessive first harmonic eccentricity value).

If the first harmonic eccentricity is within the permitted limit, the graphs can in any case be displayed by pressing the buttons **4** / **1** from the result screen:



Figure 26 - Radial eccentricity measurement graph:



Figure 27 - Radial and lateral eccentricity measurement graph.

**BLUE GRAPH:** represents the peak/peak eccentricity whose actual value is displayed and updated by turning the wheel in correspondence to the word "Cursor".

**RED GRAPH:** represents the first harmonic eccentricity. For a wheel in optimal conditions, this graph must come close to a straight line.

Under result screen the following buttons are enabled:

➤ **2 Match Bal.**

To go to rim runout measurement.

➤ **3 Print**

To print the runout values measured (option).

➤ **7 Exit**

Return to the previous screen.

## Sonar LR Instruction

In order to obtain the correct lateral eccentricity values, the sonar cone must be positioned inside the tire shoulder. The function of the LED is to make it easier to position the sonar correctly, but always bear in mind that it does not indicate the focus of the pad as it is situated 30 mm further down.

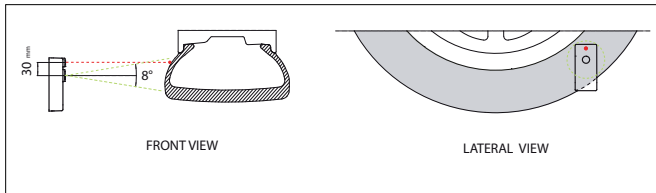

Figure 28 - Sonar Placement

The rim eccentricity measurement is important in order to try and reduce the total eccentricity of the wheel simply by turning the tire on the rim.

1. Press the button **2** from the eccentricity graph display frame
2. Hold the arm as shown in figure 29 in such a way that it does not turn during the measurement



Figure 29 - Hold Arm As Shown

3. Rest the round part of the arm inside the rim as shown in figure 30.



Figure 30 - Rest Round Part Of Arm On Rim As Shown

4. Press the **Start** button and slowly turn the wheel by hand, keeping a constant pressure on the arm until the following frame appears:

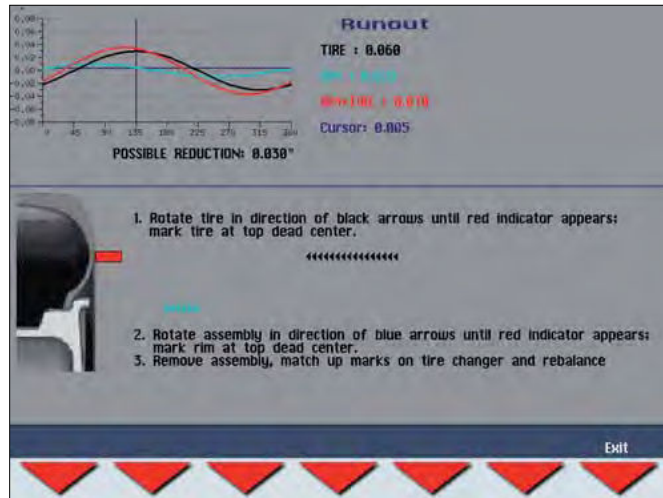

Figure 31 - Graph

The graph simultaneously shows the total eccentricity, the rim and the tire values. Before turning the tire on the rim, check if the POSSIBLE REDUCTION indicated on-screen is sufficient to bring the wheel eccentricity within tolerance. It is possible to set the minimum correction limit below which it is never considered appropriate to intervene (CORRECTION RUNOUT LIMIT), and the maximum first harmonic eccentricity limit of the rim below which it is considered of little use to turn the tire on the rim (MAX. TRUE RUNOUT LIMIT).

The following buttons are enabled:

- **3** **Print**

To print the runout values measured (option).

- **7** **Exit**

Return to the previous screen.

## Calibration Program

In order to gain access to the "Reserved Calibrations and functions" it is necessary to enter a password. Any incorrect operation within the functions described below could impair the operation of the wheel balancing machine. Unauthorized use will cause cancellation of the warranty on the machine.

### Arm Calibration

Select the gauge to be calibrated and follow the on-screen instructions.

In width gauge calibration, the dimension needs to be set:

- A - GAUGE "ZERO" DISTANCE
- SONAR "ZERO" DISTANCE

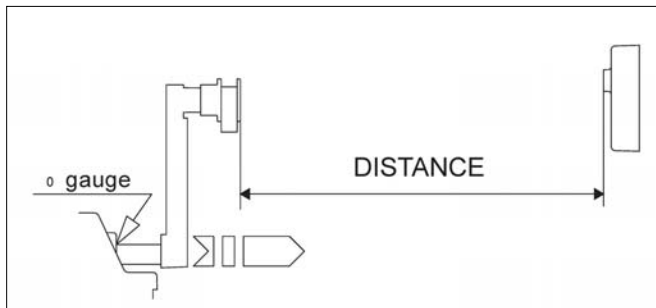

Figure 32 - Set Dimension

### Machine Calibration

For machine calibration, proceed as follows:

1. Mount an average size wheel with steel rim. Es.: 6" x 15" ( $\pm 1$ )
2. Preset the wheel dimensions with GREAT CARE.
3. Follow the on-screen instructions.

**Note:** You can change the calibration weight from 40 to 100 g (1.40 to 4.00 oz)

## Diagnostic Procedures

### After Balance Vibration Problems

If vibration is still present after balancing the wheels and driving the vehicle on smooth pavement, remove the wheels and recheck the balance. If a wheel is out of balance the cause may be:

- Wheel was not mounted/centered correctly on the balancer.
- A weight has come off the wheel (possibly the wrong clip style). Remove the other weights from the wheel and rebalance.
- Foreign material inside the tire. Remove the tire from the wheel, remove the foreign material, and remount. Remove wheel weights and rebalance the wheel.
- Stones or other foreign objects caught in the tire tread or rim. Remove the objects. Check and rebalance if needed.

If the balancer still indicates the wheels are balanced to within 0.01 ounces on both inner and outer displays, the problem is not in the balance of the wheels. Check the following possible sources of vibration:

- Tire pressure. Bring all tires up to the recommended PSI.
- Radial or lateral runout in the tire or wheel. Replace the damaged part.
- Out of balance in wheel covers or trim rings. Remove the wheel covers or trim rings and test drive. If the vibration is gone, remove the shaft and use an appropriate adapter to mount the wheel to the balancer. Balance the wheel with the wheel cover or trim ring attached to the wheel.
- Incorrectly mounted tire and wheel. Remount correctly.
- Damaged wheel bolt holes. Replace wheel.
- Worn universal joints. Replace as required.
- Drive shaft out of balance or damaged. Balance, repair, or replace.
- Out of balance in brake rotor(s) or drum(s).
- Suspension out of alignment. Align the vehicle and replace any damaged or worn parts.

## Troubleshooting

The machine recognizes a number of incorrect operations and displays this as an error message. Listed

below are faults that the user can remedy if the cause is found to be among those indicated. Any other defect or malfunction will require the attention of a qualified technician: Contact your nearest COATS® service center.

ERROR	CAUSE	REMEDY
<b>Black</b>	The wheel balancer does not switch on.	<ol style="list-style-type: none"> <li>1. Verify correct connection to the mains.</li> <li>2. Verify and eventually replace the fuses on the power card.</li> <li>3. Verify monitor function.</li> <li>4. Replace the computer board.</li> </ol>
<b>Err. 1</b>	No rotation signal.	<ol style="list-style-type: none"> <li>1. Check in self-diagnostics that the encoder functions properly.</li> <li>2. Replace the phase pick-up board.</li> <li>3. Replace the computer board.</li> </ol>
<b>Err. 2</b>	Speed too low during detection. During unbalance measurement rotation, wheel speed is less than 42 rpm.	<ol style="list-style-type: none"> <li>1. Make sure a vehicle wheel is mounted properly on wheel balancer.</li> <li>2. Check in self-diagnostics that the encoder functions properly.</li> <li>3. Disconnect the piezo connectors from the board and do a spin (if no error is detected, replace the piezo sensors).</li> <li>4. Replace the computer board.</li> </ol>
<b>Err. 3</b>	Out of balance too high.	<ol style="list-style-type: none"> <li>1. Verify wheel dimension settings.</li> <li>2. Check detection unit connections.</li> <li>3. Perform machine calibration.</li> <li>4. Mount a wheel with more or less known out of balance (less than 100 grammes) and verify the response of the machine.</li> <li>5. Replace the computer board.</li> </ol>
<b>Err. 4</b>	Rotation in opposite direction. After pressing [START], the wheel starts turning in the opposite direction (anticlockwise).	<ol style="list-style-type: none"> <li>1. Check in self-diagnostics that the encoder functions properly</li> <li>2. Check the bearing/spring of the phase generator</li> </ol>
<b>Err. 5</b>	Guard open The [START] pushbutton was pressed without first closing the guard.	<ol style="list-style-type: none"> <li>1. Reset the error by pressing pushbutton [7]=End.</li> <li>2. Close the guard.</li> <li>3. Verify the function of the protection uSwitch.</li> <li>4. Press the [START] pushbutton.</li> </ol>
<b>Err. 7, 8 or 10</b>	NOVRAM parameter read error	<ol style="list-style-type: none"> <li>1. Repeat machine calibration</li> <li>2. Shut down the machine.</li> <li>3. Wait for a minimum time of ~ 1 Min.</li> <li>4. Re-start the machine and verify correct operation.</li> <li>5. Replace the computer board.</li> </ol>
<b>Err. 9</b>	NOVRAM parameter write error.	Replace the computer board.
<b>Err. 11</b>	Speed too high error. During out of balance measurement rotation, wheel speed is more than 270 rpm.	<ol style="list-style-type: none"> <li>1. Check if there is any damage or dirt on the timing disc.</li> <li>2. Check in self-diagnostics that the encoder functions properly.</li> <li>3. Replace the computer board.</li> </ol>
<b>Err. 14, 15, 16, 17, 18 or 19</b>	Out of balance measurement error.	<ol style="list-style-type: none"> <li>1. Check in self-diagnostics that the encoder functions properly</li> <li>2. Check detection unit connections.</li> <li>3. Verify machine earth/ground connection.</li> <li>4. Mount a wheel with more or less known out of balance (less than 100 grammes) and verify the response of the machine.</li> <li>5. Replace the computer board.</li> </ol>
<b>Err. 22</b>	Maximum number of spins possible for the out of balance measurement has been exceeded.	<ol style="list-style-type: none"> <li>1. Check that a vehicle wheel has been mounted properly on the wheel balancer.</li> <li>2. Check in self-diagnostics that the encoder functions properly.</li> <li>3. Replace the computer board.</li> </ol>
<b>Err. 30</b>	Clock error	Replace the computer board.
<b>Err. 40, 41, 42 or 43</b>	Eccentricity graph plotting procedure error.	Perform a new eccentricity measurement.
<b>Err. 45, 46, 47 or 48</b>	Eccentricity graph value display read-out error.	Perform a new eccentricity measurement.
<b>Err. 50, 51, 52 or 53</b>	Eccentricity graph current value cursor plotting procedure error.	Perform a new eccentricity measurement.

<b>ERROR</b>	<b>CAUSE</b>	<b>REMEDY</b>
<b>Err.54</b>	Sonar readout error. Sonar value readout impossible.	<ol style="list-style-type: none"> <li>1. Position the eccentricity measurement sonar correctly before performing the measurement.</li> <li>2. Check eccentricity sonar connections.</li> <li>3. Check the power supplies on the power board.</li> <li>4. Replace the eccentricity measurement sonar.</li> <li>5. Make sure that the wheel does not halt before completing at least 4/5 revolutions after the first braking impulse.</li> <li>6. Verify belt tautness.</li> <li>7. Replace the computer board.</li> </ol>
<b>Err.55</b>	Sonar readout error. Sonar values are insufficient for correct measurement of eccentricity.	<ol style="list-style-type: none"> <li>1. Position the eccentricity measurement sonar correctly before performing the measurement.</li> <li>2. Make sure that the wheel does not halt before completing at least 4/5 revolutions after the first braking impulse.</li> <li>3. Verify belt tautness.</li> <li>4. Mount a wheel of medium dimensions (14"x5 3/4") and perform an eccentricity measurement. If in these conditions error 55 no longer occurs, this means that the wheel inertia causing the problem is such as to half the wheel before having acquired the minimum number of values necessary for reliable eccentricity measurement.</li> </ol>
<b>Err.56</b>	Lateral Sonar readout error. Lateral Sonar value readout impossible.	<ol style="list-style-type: none"> <li>1. Position the eccentricity measurement lateral sonar correctly before performing the measurement.</li> <li>2. Check eccentricity lateral sonar connections.</li> <li>3. Check the power supplies on the power board.</li> <li>4. Replace the eccentricity lateral sonar.</li> <li>5. Make sure that the wheel does not stop before completing at least 4/5 revolutions after the first braking impulse.</li> <li>6. Verify belt tautness.</li> <li>7. Replace the computer board.</li> </ol>
<b>Err.57</b>	Lateral Sonar readout error. Lateral Sonar values are insufficient for correct measurement of lateral eccentricity.	<ol style="list-style-type: none"> <li>1. Position the eccentricity lateral sonar correctly before performing the measurement.</li> <li>2. Make sure that the wheel does not stop before completing at least 4/5 revolutions after the first braking impulse.</li> <li>3. Verify belt tautness.</li> <li>4. Mount a wheel of medium dimensions (14"x5 3/4") and perform an eccentricity measurement. If in these conditions error 57 no longer occurs, this means that the wheel inertia causing the problem is such as to half the wheel before having acquired the minimum number of values necessary for reliable lateral eccentricity measurement.</li> </ol>
<b>Err.58</b>	Radial and lateral Sonar readout error. Radial and lateral Sonar value readout impossible.	<ol style="list-style-type: none"> <li>1. Check points Err. 54</li> <li>2. Check points Err. 56</li> </ol>
<b>Err.59</b>	Radial and lateral Sonar readout error. Lateral and radial Sonar values are insufficient for correct measurement of radial and lateral eccentricity.	<ol style="list-style-type: none"> <li>1. Check points Err. 55</li> <li>2. Check points Err. 57</li> </ol>
<b>Err.65</b>	Printer timeout	<ol style="list-style-type: none"> <li>1. Check that a printer is present.</li> <li>2. Check the code of the processor card.</li> <li>3. Check the printer &lt;-&gt; processor card connection.</li> <li>4. Run the printer test function.</li> </ol>
<b>Err.66</b>	Printer buffer error	<ol style="list-style-type: none"> <li>1. Reset the printer.</li> <li>2. Repeat the print function.</li> </ol>
<b>Err.70</b>	Error regarding ADC 16 bit readings	<ol style="list-style-type: none"> <li>1. Check correct connection cable for distance and diameter gauge (CN5/CN4).</li> <li>2. Switch off the machine, wait about 30 seconds and switch on again.</li> <li>3. Replace the PC board.</li> </ol>
<b>Out of balance incorrect with back centering cone</b>	Wheel slipping on the adapter because the BP system is at the end of travel or because of incorrect fitting of the tire tie-rod.	Mount the wheel in vertical position and push the sleeve up against the wheel. If necessary, repeat locking/unlocking/locking and perform the procedure again.

## Maintenance Instructions

The balancer requires only minor maintenance to keep the unit operating properly.

**1.** Keep the display clean and clear. Use a damp cloth. Do not use cleaners or solvents which leave oily or filmy residues behind.

**2.** Keep the adapters, cones, faceplate, threaded shaft, pressure cup, and hub nut clean. Grease and dirt buildup will cause inaccurate balancing and premature wear. Clean these items at least once a day with a vaporizing solvent.

**3.** Clean weight tray and any accessory posts, pegs, or storage shelves with a vaporizing solvent. Weights stored in a dirty tray may pick up grease and dirt which may keep them from securely attaching to the wheel.

**4.** Keep the area around and under the balancer clear. Remove any tools or other items that are leaning against the balancer. Remove any items that may cause the balancer to not sit level. Be particularly cautious of new or used wheel weights on the floor, as they may cause personal injury due to falls.

**5.** Use only COATS® accessories. Accessories from other manufacturers may not fit or function properly, and may damage the balancer.

**Important:** Always be sure to remove the wheel assembly from the pneumatic shaft before disconnecting the air supply from the machine.



**Use common sense, this is an electrical device. Exposing the balancer to water, either by hose or bucket, or by exposure to rain or snow, may cause risk of shock or electrocution to operator or bystanders. Place, store, and operate the balancer only in a dry, sheltered location.**



**Do not hose down with water or bucket wash the balancer. Extensive damage to the balancer will result. Sensitive electronic components, wiring harnesses, and other devices housed in the balancer are not intended to be exposed to water.**



## Glossary

**ALUS** -Alloy wheel mode that typically requires the use of one or two adhesive weights for correction.

**Balancer Flange** – Disk that mates with the disk of the wheel mounted to the balancer. The flange also serves to keep the wheel perfectly perpendicular to its axis of rotation.

**Balancing Cycle** – Sequence of operations performed by the user and the machine, beginning from the start of the wheel spin to the time that the wheel is braked to a standstill after the out of balance signals are acquired and the relative values calculated.

**Centering** – Procedure for positioning the wheel on the spindle shaft with the aim of ensuring that the rotational axis of the wheel is aligned with the center of the shaft.

**Centering Flange (accessory)** – Device serving to support and center the wheel. Also keeps the wheel perfectly perpendicular to its axis of rotation. The centering flange is mounted to the balancer shaft by means of its center hole.

**Cone** – Conical components with center hole. When inserted on the spin shaft, serves to center wheels with centre holes whose diameter is between maximum and minimum values.

**Dynamic Balancing** – Operation in which out of balance is corrected by the application of two weights, one on each side of the wheel.

**Self-calibration** – A procedure whereby suitable correction coefficients are calculated by starting from known operating conditions. Self-calibration improves the measurement precision of the machine by correcting, within limits, calculation errors that may arise due to alteration of the machine's characteristic over the course of time.

**Spin** – Procedure starting from the action that causes the wheel to rotate and the successive free rotation of the wheel.

**Hubnut** – Device for clamping the wheel to the balancer. The hubnut features elements for engaging to the threaded hub and lateral pins that are used to tighten it.

**Static Balancing** – In static balancing only the static component of out of balance is corrected. This is achieved by fitting a single weight, usually at the center of the rim channel. The accuracy of this system increases as the width of the wheel decreases.

**Threaded Hub** – Threaded part of the shaft that is engaged with the hubnut to clamp the wheel. This component is supplied disassembled from the machine.

**Out of balance** – Non-uniform distribution of the wheel mass that results in the generation of centrifugal force during rotation.

